



GAST

Endüstriyel Mutfak ve Makine Sanayi



ÜRÜN KATALOĞU
PRODUCT CATALOGUE

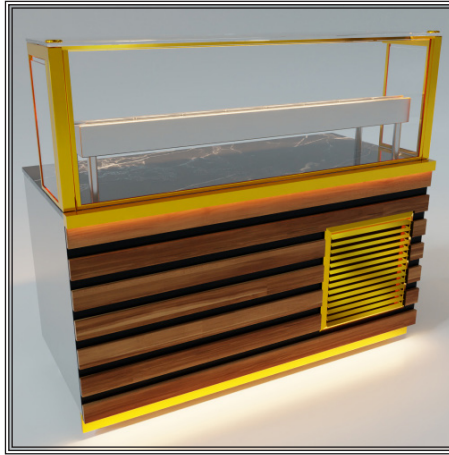
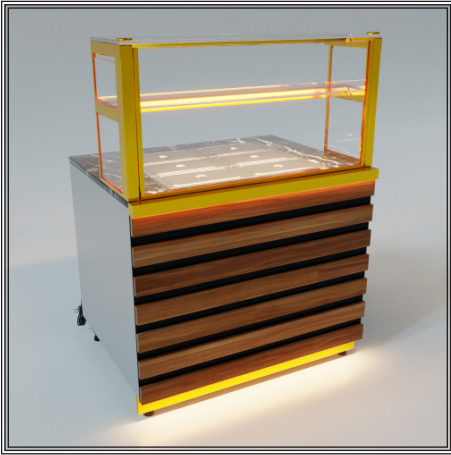

HAKKIMIZDA

Firmamız 2006 yılından itibaren mutfak sektöründe hizmet vermektedir. Proje, danışmanlık ve satış sonrası hizmeti ile sektöründe güvenilir, çalışma disiplini ve müşterileri ile sürekli diyalog halinde kalarak işletmelerinizin desteğe ihtiyacı olduğu her an kalite ve güven anlayışı ile hizmet vermeye devam etmektedir. Sorumluluk bilinci ile devam eden müşteri ilişkileri sayesinde sektöründe rakiplerinden her zaman önde yer almaktadır.

Hastane, restoran, kafe, kantin, otel, sosyal tesis, okul ve fabrika mutfakları vb birçok küçük büyük işletmenin ihtiyaç duyacağı; pişirme, ısıtıcı, soğutucu, hazırlık malzemeleri, saklama, taşıma ve servis ekipmanları alanlarında geniş ürün yelpazesi ile işletme mutfaklarınızın projelendirilmesi, kurulumu ve servis desteğini sağlamaktadır.

Kurulduğu günden bu güne geçen sürede üretim ve hizmet anlayışıyla Gast Markasını kalitenin yeni adresi olmuştur.

Vizyonumuz...

Ürünlerimizde modern üretim teknikleri kullanmak, müşteri ihtiyaçlarını kalite ve uygun fiyat ilkemiz ile karşılamaktır.

Misyonumuz...

Gast olarak her zaman önceliğimiz; kaliteden ödün vermeden, uygun fiyat avantajı ile güvenilir müşteri ilişkileri sağlamaktır.

ABOUT US

Our company has been serving in the kitchen sector since 2006. With its project, consultancy and after-sales service, it continues to serve with an understanding of quality and trust at any time when your business needs support by staying in constant dialogue with its reliable, working discipline and customers. Thanks to its ongoing customer relations with a sense of responsibility, it is always ahead of its competitors in the sector.

Hospital, restaurant, cafe, cafeteria, canteen, hotel, social facility, school and factory kitchens etc. that many small and large businesses will need; It provides project design, installation and service support for your business kitchens with a wide range of products in the fields of cooking, heating, cooling, preparation materials, storage, transport and service equipment.

Gast Brand has become the new address of quality with its understanding of production and service since its establishment.

Our Vision...

To use modern production techniques in our products, to meet customer needs with our principle of quality and reasonable price.

Our Mission...

As Gast, our priority is to provide reliable customer relations with reasonable price advantage without sacrificing quality.



630 LUK SERİ / 630 SERIES / <i>Série des 630</i>	7-23
700 LÜK SERİ / 700 SERIES / <i>Série des 700</i>	24-49
930 LUK SERİ / 930 SERIES / <i>Série des 930</i>	50-71
KAFETERYA / CAFE / <i>Cafeterias</i>	72-80
KUZİNELER / RANGES / <i>Cuisinières</i>	81-85
KOSAN OCAKLARI / STOVES / <i>Cusinière à Sol</i>	86-87
WOK OCAKLAR / WOK COOCKERS / <i>Cuiser Wok</i>	88-89
FIRINLAR / OVENS / <i>Fours</i>	90-92
PİZZA FIRINLARI / PIZZA OVENS / <i>Fours à Pizza</i>	93-95
SOĞUK ÜNİTELER / COLD UNITS / <i>Unités Froides</i>	96-121
İÇECEK DISPANSERLERİ / BEVERAGE DISPANSERS / <i>Dispansaires De Bosisons</i>	122-123
ÇAY OCAKLARI / TEA KITCHENS / <i>Cuisines A Thes</i>	124-125
ET & KIYMA MAKİNALARI / MEAT & MINCING MACHINES	126-129
BULAŞIK MAKİNELERİ / DISHWASHER / <i>Lave-Verre</i>	130-135
TEZGAHLAR / BENCHES / <i>Comptoirs</i>	136-139
BAR MODÜLLERİ / BENCHES / <i>Comptoirs</i>	140-145

630 LUK SERİ
630 SERIES / Série des 630





630 LUK SERİ
630 SERIES
Série des 630

TEKLİ BÜYÜK FRİTÖZ / SINGLE BIG FRYER / GRANDE FRITEUSE 1 BAC



- TR**
- Paslanmaz çelik gövde
 - Hareketli ısıtıcılar sayesinde kolay temizlik
 - Hijyenik
 - 100-180 °C ayarlı termostat
 - Ayarlanabilir ayaklar
 - Uzun ömürlü
 - Set üstü olarak kullanılır

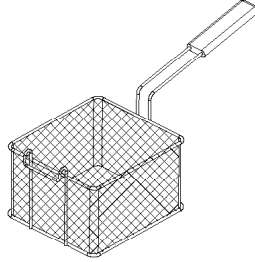

KOD CODE	EBATLAR DIMENSIONS	FİYAT PRICE
GAST-5FSPT.02	195 x 215 x 130	22 €

GAST-6FE27

ÇİFTLİ MİNİ FRİTÖZ / DOUBLE SMALL FRYER / PETITE FRITEUSE 2 BACS



- EN**
- Stainless steel body
 - Easy to clean
 - Hygienic
 - 100-180 °C Adjustable thermostat
 - Adjustable legs
 - Long life
 - Using over bench

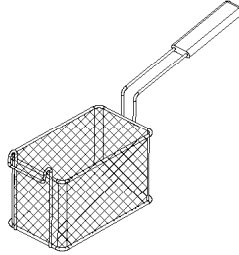

KOD CODE	EBATLAR DIMENSIONS	FİYAT PRICE
GAST-3FSPT.01	125 x 215 x 130	20 €

GAST-6FE35

ÇİFTLİ BÜYÜK FRİTÖZ / DOUBLE BIG FRYER / GRANDE FRITEUSE 2 BACS



- FR**
- Boîtier en acier inoxydable
 - Nettoyage facile avec chauffage mobile
 - Hygiénique
 - Thermostat réglable 100°C- 180°C
 - Pieds soutien réglable
 - Longue durée de vie
 - Utilisable sur planche

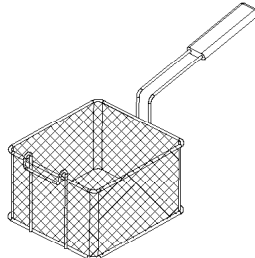

KOD CODE	EBATLAR DIMENSIONS	FİYAT PRICE
GAST-5FSPT.02	195 x 215 x 130	22 €

GAST-6FE55

KOD CODE	MODEL DESCRIPTION	EBATLAR DIMENSIONS	LİTRE LITER	KG KG	GÜÇ POWER	ENERJİ ENERGY	FİYAT PRICE
GAST-6FE27	Tekli Büyük Fritöz Electric Fryer With 1 Basket	270 x 630 x 300	5 Lt.	12 Kg.	3 kW	230 V ~ 50 Hz	360€
GAST-6FE35	Çiftli Mini Fritöz Electric Fryer With 2 Baskets	350 x 630 x 300	3+3 Lt.	14 Kg.	6 kW	230 V ~ 50 Hz	480 €
GAST-6FE55	Çiftli Büyük Fritöz Electric Fryer With 2 Baskets	530 x 630 x 300	5+5 Lt.	19 Kg.	6 kW	230 V ~ 50 Hz	550 €

40 LİK TEKLİ ELEKTRİKLİ FRİTÖZ / ELECTRIC FRYER / FRITEUSE



- TR**
- Paslanmaz çelik gövde
 - Hareketli ısıtıcılar sayesinde kolay temizlik
 - Hijyenik
 - Tahliye Vanası
 - Yekpare bankolu havuz
 - Emniyet termostadı
 - 100-180 °C ayarlı termostat
 - Ayarlanabilir ayaklar
 - Uzun ömürlü
 - Set üstü olarak kullanılır

- EN**
- Stainless steel body
 - Easy to clean
 - Hygienic
 - With drainage pipe
 - Monoblock bowl
 - Safety thermostat
 - 100-180 °C Adjustable thermostat
 - Adjustable legs
 - Long life
 - Using over bench

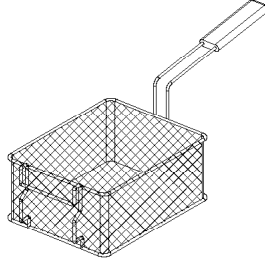

GAST-6FE40

KOD CODE	EBATLAR DIMENSIONS	FİYAT PRICE
GAST-6EFSPT.01	208 x 263 x 114	26 €

60 LİK ÇİFTLİ ELEKTRİKLİ FRİTÖZ / ELECTRIC FRYER / FRITEUSE



- FR**
- Boitier en acier inoxydable
 - Nettoyage facile avec chauffage mobile
 - Hygiénique
 - Soupape d'évacuation
 - Bac monobloc
 - Thermostat de sécurité
 - Thermostat réglable 100°C- 180°C
 - Pieds soutien réglable
 - Longue durée de vie
 - Utilisable sur planche



GAST-6FE60

KOD CODE	MODEL DESCRIPTION	EBATLAR DIMENSIONS	LİTRE LITER	KG KG	GÜÇ POWER	ENERJİ ENERGY	FİYAT PRICE
GAST-6FE40	40 lık Tekli Elektrikli Fritöz Electric Fryer With 1 Basket	400 x 630 x 300	8 Lt.	18 Kg.	9 kW	400 V 3 ~ 60 Hz	990 €
GAST-6FE60	60 lık Çiftli Elektrikli Fritöz Electric Fryer With 2 Baskets	600 x 630 x 300	8+8 Lt.	25 Kg.	18 kW	400 V 3 ~ 60 Hz	1.635 €

40 LİK TEKLİ ELEKTRİKLİ DİJİTAL FRİTÖZ / ELECTRIC DIGITAL FRYER / FRITEUSE DIGITAL



TR

- Paslanmaz çelik gövde
- Hareketli ısıtıcılar sayesinde kolay temizlik
- Hijyenik
- Tahliye Vanası
- Yekpare bankolu havuz
- Emniyet termostadı
- 100-180 °C ayarlı dijital termostat
- Ayarlanabilir ayaklar
- Uzun ömürlü
- Set üstü olarak kullanılır



GAST-6FED40

EN

- Stainless steel body
- Easy to clean
- Hygienic
- With drainage pipe
- Monoblock bowl
- Safety thermostat
- 100-180 °C Adjustable digital thermostat
- Adjustable legs
- Long life
- Using over bench

60 LİK ÇİFTLİ ELEKTRİKLİ DİJİTAL FRİTÖZ / ELECTRIC DIGITAL FRYER / FRITEUSE DIGITAL



FR

- Boîtier en acier inoxydable
- Nettoyage facile avec chauffage mobile
- Hygiénique
- Soupape d'évacuation
- Bac monobloc
- Thermostat de sécurité
- Thermostat digital réglable 100°C- 180°C
- Pieds soutien réglable
- Longue durée de vie
- Utilisable sur planche



GAST-6FED60

KOD CODE	MODEL DESCRIPTION	EBATLAR DIMENSIONS	LİTRE LITER	KG KG	GÜÇ POWER	ENERJİ ENERGY	FİYAT PRICE
GAST-6FED40	40 lık Tekli Elektrikli Dijital Fritöz Electric Digital Fryer With 1 Basket	400 x 630 x 300	8 Lt.	18 Kg.	9 kW	400 V 3 ~ 60 Hz	1.240 €
GAST-6FED60	60 lık Çiftli Elektrikli Dijital Fritöz Electric Digital Fryer With 2 Baskets	600 x 630 x 300	8+8 Lt.	25 Kg.	18 kW	400 V 3 ~ 60 Hz	2.140 €

40 LİK GAZLI FRİTÖZ / GAS FRYER / GRANDE FRITEUSE A GAZ



- TR**
- Paslanmaz çelik gövde
 - Piezoelektrik ateşlemeli pilot
 - LPG ve Doğalgaz uyumlu
 - Yekpare bankolu havuz
 - Emniyet termostatu
 - 100°C-180°C ayarlı termostat
 - 8 lt yağ kapasitesi
 - Ayarlanabilir ayaklar
 - Set üstü ve dolaplı kullanıma uygundur.



GAST-6FG40

- EN**
- Stainless steel body
 - Safety gas thermostat 100°C-180°C
 - Piezoelectric ignition and pilot flame
 - Available for LPG and Natural Gas
 - Monoblock bowl
 - 8 lt frying capacity
 - Available legs
 - Using over bench

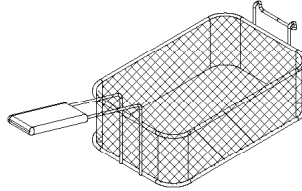

KOD CODE	EBATLAR DIMENSIONS	FİYAT PRICE
GAST-6GFSP.04	204 x 320 x 100	30 €

60 LİK GAZLI FRİTÖZ / GAS FRYER / GRANDE FRITEUSE A GAZ



- FR**
- Adaptable à fonctionner au GPL ou GN.
 - Commande thermostatique.
 - Panier en acier inoxydable.
 - Robinet de sécurité magnétique.
 - Vanne de vidange d'huile.
 - Sécurité du thermostat contre la surchauffe.
 - Nettoyage facile grâce à la conception hygiénique.
 - Corps en acier inoxydable



GAST-6FG60

KOD CODE	MODEL DESCRIPTION	EBATLAR DIMENSIONS	LİTRE LITER	KG KG	GÜÇ POWER	DG SARFIYAT N.GAS EXPENDITURE	BASINÇ PRESSURE	FİYAT PRICE
GAST-6FG40	40 lık Gazlı Fritöz Gas Fryer With 1 Basket	400 x 630 x 300	8 Lt.	21 Kg.	7 kW	0,73 m ³	20 mbar	1.385 €
GAST-6FG60	60 lık Gazlı Fritöz Gas Fryer With 2 Baskets	600 x 630 x 300	8+8 Lt.	34 Kg.	14 kW	1,46 m ³	20 mbar	2.265 €

2 Lİ GAZLI OCAK / GAS COOKER WITH 2 BURNERS / CUISINIÈRE GAZ A 2 BRÛLEURS   

- TR**
- Paslanmaz çelik gövde
 - Alev denetleme tertibatı ve pilot yanış sistemli
 - Sanayi tipi döküm
 - LPG ve Doğalgaza uyumlu
 - Ayarlanabilir ayaklar
 - Kolay temizlenebilir
 - Set üstü olarak kullanılır.

- EN**
- Stainless steel body
 - Valves able to control max and min
 - Heavy duty top cast iron
 - Available LPG or Natural Gas
 - Adjustable legs
 - Easy to clean
 - Using over bench



GAST-60CG40

4 LÜ GAZLI OCAK / GAS COOKER WITH 4 BURNERS / CUISINIÈRE GAZ A 4 BRÛLEURS   

- FR**
- Boitier en acier inoxydable
 - Commande des valves au max/min
 - Fonte de type industriel
 - Compatible au GPL et gaz naturel
 - Pieds soutien réglable
 - Nettoyage facile
 - Utilisable sur planche



GAST-60CG60

KOD CODE	MODEL DESCRIPTION	EBATLAR DIMENSIONS	KG KG	GÜÇ POWER	DG SARFIYAT N.GAS EXPENDITURE	BASINÇ PRESSURE	FİYAT PRICE
GAST-60CG40	2 li Gazlı Ocak Gas Cooker With 2 Burners	400 x 630 x 300	18 Kg.	11 kW	1,04 m ³	20 mbar	600 €
GAST-60CG60	4 lü Gazlı Ocak Gas Cooker With 4 Burners	600 x 630 x 300	30 Kg.	22 kW	2,08 m ³	20 mbar	920 €

DG-400

LPG-401

DG-600

LPG-601

2 Lİ ELEKTRİKLİ OCAK / ELECTRIC COOKER 2 HOT PLATES / CUISINIÈRE ELECTRIQUE A 2 PLAQUES CHAUFFANTES   

- TR**
- Paslanmaz çelik gövde
 - Pik dökümlü 20 cm pleytler
 - 3 kademeli kontrol edilebilir
 - Ayarlanabilir ayaklar
 - Kolay temizlenebilir.
 - Set üstü olarak kullanılır.

- EN**
- Stainless steel body
 - 20 cm diameter heaters
 - Adjustable cotrol system
 - Adjustable legs
 - Easy to clean
 - Using over bench



GAST-60CE40

4 LÜ ELEKTRİKLİ OCAK / ELECTRIC COOKER 4 HOT PLATES / CUISINIÈRE ELECTRIQUE A 4 PLAQUES CHAUFFANTES   

- FR**
- Boitier en acier inoxydable
 - Les plates de fonte à 20 cm
 - Contrôle à 3 niveaux graduels
 - Pieds soutien réglable
 - Nettoyage facile
 - Utilisable sur planche

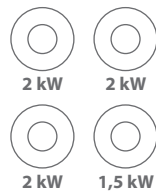

GAST-60CE60

KOD CODE	MODEL DESCRIPTION	EBATLAR DIMENSIONS	KG KG	GÜÇ POWER	ENERJİ ENERGY	FİYAT PRICE
GAST-60CE40	2 li Elektrikli Ocak Electric Cooker With 2 Hot Plates	400 x 630 x 300	14 Kg.	4 kW	230 V ~ 50 Hz	570 €
GAST-60CE60	4 lü Elektrikli Ocak Electric Cooker With 4 Hot Plates	600 x 630 x 300	28 Kg.	7,5 kW	400 V 3 ~ 60 Hz	875 €

40 LİK GAZLI IZGARA / GAS GRILL PLATE / GRILL A GAZ



- TR**
- Paslanmaz çelik gövde
 - LPG ve Doğalgaza uyumlu
 - Pişirme yüzeyi düz, yarı oluklu ve oluklu olarak 3 model
 - 80'lik modellerde ayrı ayrı kontrol edilebilen pişirme yüzeyi
 - Piezoelektrik ateşlemeli, pilotlu
 - Ayarlanabilir ayaklar
 - Homojen pişirme yüzeyi
 - Yağ toplama kanalı, boşaltma çekmecesini
 - Kolay temizlenebilir
 - Set üstü olarak kullanılır



GAST-6PIG40YO

60 LİK GAZLI IZGARA / GAS GRILL PLATE / GRILL A GAZ



- EN**
- Stainless steel body
 - Available LPG or Natural Gas
 - Types of cooking plate (smooth, 1/2 nervour and nervour)
 - Cooking zone is controlled by 2 different valves separately
 - Piezoelectric ignition, pilot flame
 - Adjustable legs
 - Equal temperature distribution on the cooking surface
 - Fat collecting drawer
 - Easy to clean
 - Using over bench



GAST-6PIG60YO

80 LİK GAZLI IZGARA / GAS GRILL PLATE / GRILL A GAZ



- FR**
- Boîtier en acier inoxydable
 - Nettoyage facile avec chauffage mobile
 - Modèles 80 cm contrôle cuisson séparable pour surface plate, demi lisse, demi rainuré
 - Cuisson surface plate réglable
 - Pieds réglable
 - Cuisson homogène surface plate
 - Canal de collecte de graisse-tiroir déchargeur
 - Nettoyage facile
 - Utilisable sur planche



GAST-6PIG80YO

KOD CODE	MODEL DESCRIPTION	EBATLAR DIMENSIONS	KG KG	GÜÇ POWER	DG SARFIYAT N.GAS EXPENDITURE	BASINÇ PRESSURE	FİYAT PRICE	FİYAT PRICE	FİYAT PRICE
GAST-6PIG40	40 lık Gazlı Izgara Gas Grill Plate	400 x 630 x 300	36 Kg.	5 kW	0,52 m ³	20 mbar	730 €	740 €	750 €
GAST-6PIG60	60 lık Gazlı Izgara Gas Grill Plate	600 x 630 x 300	46 Kg.	10 kW	1,04 m ³	20 mbar	1.040 €	1.050 €	1.065 €
GAST-6PIG80	80 lık Gazlı Izgara Gas Grill Plate	800 x 630 x 300	64 Kg.	10 kW	1,04 m ³	20 mbar	1.120 €	1.135 €	1.135 €

	GAST-6PIG40		GAST-6PIG40YO		GAST-6PIG40TO			
	GAST-6PIG60		GAST-6PIG60YO		GAST-6PIG60TO			
	GAST-6PIG80		GAST-6PIG80YO		GAST-6PIG80TO			

40 LİK KROM GAZLI IZGARA / GAS CHROME GRILL PLATE / GRILL A GAZ CHROME



- TR**
- Paslanmaz çelik gövde
 - LPG ve Doğalgaza uyumlu
 - Pişirme yüzeyi düz, yarı oluklu ve oluklu olarak 3 model
 - 80'lik modellerde ayrı ayrı kontrol edilebilen pişirme yüzeyi
 - Piezoelektrik ateşlemeli, pilotlu
 - Ayarlanabilir ayaklar
 - Homojen pişirme yüzeyi
 - Yağ toplama kanalı, boşaltma çekmecesini
 - Kolay temizlenebilir
 - Set üstü olarak kullanılır



GAST-6PIG40KYO

60 LİK KROM GAZLI IZGARA / GAS CHROME GRILL PLATE / GRILL A GAZ CHROME



- EN**
- Stainless steel body
 - Available LPG or Natural Gas
 - Types of cooking plate (smooth, 1/2 nervour and nervour)
 - Cooking zone is controlled by 2 different valves separately
 - Piezoelectric ignition, pilot flame
 - Adjustable legs
 - Equal temperature distribution on the cooking surface
 - Fat collecting drawer
 - Easy to clean
 - Using over bench



GAST-6PIG60KYO

80 LİK KROM GAZLI IZGARA / GAS CHROME GRILL PLATE / GRILL A GAZ CHROME



- FR**
- Boîtier en acier inoxydable
 - Nettoyage facile avec chauffage mobile
 - Modèles 80 cm contrôle cuisson séparable pour surface plate, demi lisse, demi rainuré
 - Cuisson surface plate réglable
 - Pieds réglable
 - Cuisson homogène surface plate
 - Canal de collecte de graisse-tiroir déchargeur
 - Nettoyage facile
 - Utilisable sur planche



GAST-6PIG80KYO

KOD CODE	MODEL DESCRIPTION	EBATLAR DIMENSIONS	KG KG	GÜÇ POWER	DG SARFIYAT N.GAS EXPENDITURE	BASINÇ PRESSURE	FİYAT PRICE	FİYAT PRICE	FİYAT PRICE
GAST-6PIG40K	40 lık Gazlı Krom Izgara Gas Chrome Grill Plate	400 x 630 x 300	36 Kg.	5 kW	0,52 m ³	20 mbar	1.195 €	1.295 €	1.310 €
GAST-6PIG60K	60 lık Gazlı Krom Izgara Gas Chrome Grill Plate	600 x 630 x 300	46 Kg.	10 kW	1,04 m ³	20 mbar	1.660 €	1.750 €	1.770 €
GAST-6PIG80K	80 lık Gazlı Krom Izgara Gas Chrome Grill Plate	800 x 630 x 300	64 Kg.	10 kW	1,04 m ³	20 mbar	1.755 €	1.885 €	1.935 €

	GAST-6PIG40K		GAST-6PIG40KYO		GAST-6PIG40KTO			
	GAST-6PIG60K		GAST-6PIG60KYO		GAST-6PIG60KTO			
	GAST-6PIG80K		GAST-6PIG80KYO		GAST-6PIG80KTO			

40 LİK ELEKTRİKLİ IZGARA / ELECTRIC GRILL PLATES / GRILL ELECTRIQUE



- TR**
- Paslanmaz çelik gövde
 - Pişirme yüzeyi düz, yarı oluklu ve oluklu olarak 3 model
 - 80'lik modellerde ayrı ayrı kontrol edilebilen pişirme yüzeyi
 - Pişirme yüzeyi 50-300°C arası ayarlanabilir
 - Ayarlanabilir ayaklar
 - Homojen pişirme yüzeyi
 - Yağ toplama kanalı, boşaltma çekmecesini
 - Kolay temizlenebilir
 - Set üstü olarak kullanılır



GAST-6PIE40YO

60 LİK ELEKTRİKLİ IZGARA / ELECTRIC GRILL PLATES / GRILL ELECTRIQUE



- EN**
- Stainless steel body
 - Types of cooking plate (smooth, 1/2 nervour and nervour)
 - Cooking zone is controlled by 2 different valves separately
 - Thermostat adjustment from 50-300°C
 - Adjustable legs
 - Equal temperature distribution on the cooking surface
 - Fat collecting drawer
 - Easy to clean
 - Using over bench



GAST-6PIE60YO

80 LİK ELEKTRİKLİ IZGARA / ELECTRIC GRILL PLATES / GRILL ELECTRIQUE



- FR**
- Boitier en acier inoxydable
 - Compatible au GPL et gaz naturel
 - Cuisson a 3 modèles (surface plate, rainuré demi rainuré)
 - Série 80 cm contrôle de cuisson séperable sur surface plate
 - Pieds réglable
 - Cuisson homogène
 - Canal de collecte de graisse-tiroir déchargeur
 - Nettoyage facile
 - Utilisable sur planche



GAST-6PIE80YO

KOD CODE	MODEL DESCRIPTION	EBATLAR DIMENSIONS	KG KG	GÜÇ POWER	ENERJİ ENERGY	FİYAT PRICE	FİYAT PRICE	FİYAT PRICE
GAST-6PIE40	40 lık Elektrikli Izgara Electric Grill Plate	400 x 630 x 300	36 Kg.	4,5 kW	400 V 3 ~ 60 Hz	755 €	765 €	775 €
GAST-6PIE60	60 lık Elektrikli Izgara Electric Grill Plate	600 x 630 x 300	46 Kg.	9 kW	400 V 3 ~ 60 Hz	1.065 €	1.075 €	1.090 €
GAST-6PIE80	80 lık Elektrikli Izgara Electric Grill Plate	800 x 630 x 300	64 Kg.	9 kW	400 V 3 ~ 60 Hz	1.145 €	1.160 €	1.175 €

	GAST-6PIE40		GAST-6PIE40YO		GAST-6PIE40TO			
	GAST-6PIE60		GAST-6PIE60YO		GAST-6PIE60TO			
	GAST-6PIE80		GAST-6PIE80YO		GAST-6PIE80TO			

40 LİK ELEKTRİKLİ KROM IZGARA / ELECTRIC CHROME GRILL PLATES / GRILL ELECTRIQUE CHROME



TR

- Paslanmaz çelik gövde
- Krom pişirme yüzeyi
- Pişirme yüzeyi düz, yarı oluklu ve oluklu olarak 3 model
- 80'lik modellerde ayrı ayrı kontrol edilebilen pişirme yüzeyi
- Pişirme yüzeyi 50-300°C arası ayarlanabilir
- Ayarlanabilir ayaklar
- Homojen pişirme yüzeyi
- Yağ toplama kanalı, boşaltma çekmecesini
- Kolay temizlenebilir
- Set üstü olarak kullanılır



GAST-6PIKE40YO

60 LİK ELEKTRİKLİ KROM IZGARA / ELECTRIC CHROME GRILL PLATES / GRILL ELECTRIQUE CHROME



EN

- Stainless steel body
- Chrome cooking surface
- Types of cooking plate (smooth, 1/2 nervour and nervour)
- Cooking zone is controlled by 2 different valves separately
- Thermostat adjustment from 50-300°C
- Adjustable legs
- Equal temperature distribution on the cooking surface
- Fat collecting drawer
- Easy to clean
- Using over bench



GAST-6PIKE60YO

80 LİK ELEKTRİKLİ KROM IZGARA / ELECTRIC CHROME GRILL PLATES / GRILL ELECTRIQUE CHROME









FR

- Boîtier en acier inoxydable
- Cuisson Chrome
- Compatible au GPL et gaz naturel
- Cuisson a 3 modèles (surface plate, rainuré demi rainuré)
- Série 80 cm contrôle de cuisson séparable sur surface plate
- Pieds réglable
- Cuisson homogène
- Canal de collecte de graisse-tiroir déchargeur
- Nettoyage facile
- Utilisable sur planche



GAST-6PIKE80YO

KOD CODE	MODEL DESCRIPTION	EBATLAR DIMENSIONS	KG KG	GÜÇ POWER	ENERJİ ENERGY	FİYAT PRICE	FİYAT PRICE	FİYAT PRICE
GAST-6PIKE40	40 lık Elektrikli Krom Izgara Electric Chrome Grill Plate	400 x 630 x 300	36 Kg.	4,5 kW	400 V 3 ~ 60 Hz	1.200 €	1.300 €	1.320 €
GAST-6PIKE60	60 lık Elektrikli Krom Izgara Electric Chrome Grill Plate	600 x 630 x 300	46 Kg.	9 kW	400 V 3 ~ 60 Hz	1.865 €	1.955 €	1.975 €
GAST-6PIKE80	80 lık Elektrikli Krom Izgara Electric Chrome Grill Plate	800 x 630 x 300	64 Kg.	9 kW	400 V 3 ~ 60 Hz	1.965 €	2.055 €	2.215 €
	GAST-6PIKE40 GAST-6PIKE60 GAST-6PIKE80		GAST-6PIKE40YO GAST-6PIKE60YO GAST-6PIKE80YO		GAST-6PIKE40TO GAST-6PIKE60TO GAST-6PIKE80TO			

40 LİK LAVATAŞ IZGARA / LAVASTONE GRILL / GRILL A PIERRE DE LAVE



- TR**
- Paslanmaz çelik gövde
 - Emniyet ventilli valf
 - Pilot alevi
 - LPG ve Doğalgaza uyumlu
 - Yağ toplama kanalı, boşaltma çekmecesini
 - Ayarlanabilir ayaklar
 - Kolay temizlenebilir
 - Set üstü olarak kullanılır

- EN**
- Stainless steel body
 - Safety gas valve with thermocouple
 - Pilot flame
 - Available LPG or Natural Gas
 - Fat collecting drawer
 - Adjustable legs
 - Easy to clean
 - Using over bench



GAST-6LIG40

80 LİK LAVATAŞ IZGARA / LAVASTONE GRILL / GRILL A PIERRE DE LAVE



- FR**
- Boîtier en acier inoxydable
 - Thermo couple
 - Pilote d'alumage
 - Valable pour tube à gaz ou gaz naturel
 - Canal de collecte de graisse–Tiroir déchargeur
 - Fonte de type industriel
 - Pieds réglable
 - Nettoyage facile
 - Utilisable sur planche



GAST-6LIG80

KOD CODE	MODEL DESCRIPTION	EBATLAR DIMENSIONS	KG KG	GÜÇ POWER	DG SARFIYAT N.GAS EXPENDITURE	BASINÇ PRESSURE	FİYAT PRICE
GAST-6LIG40	40 lık Lavataş Izgara Lavastone Grill	400 x 630 x 300	39 Kg.	5 kW	0,52 m ³	20 mbar	775 €
GAST-6LIG80	80 lık Lavataş Izgara Lavastone Grill	800 x 630 x 300	71 Kg.	10 kW	1,04 m ³	20 mbar	1.145 €

DG-40

LPG-41

DG-80

LPG-81

40 LİK MAKARNA HAŞLAMA / PASTA COOKER / CUISEUR À PÂTE



- TR**
- Paslanmaz çelik gövde
 - Kolay temizlik
 - Hijyenik
 - Tahliye vanası
 - Yekpare havuz
 - 30-120°C ayarlı termostat
 - 8 litre kaynatma kapasitesi
 - Ayarlanabilir ayaklar
 - Uzun ömürlü
 - Set üstü olarak kullanılır.

- EN**
- Stainless steel body
 - Easy to clean
 - Hygienic
 - With drainage pipe
 - Monoblock bowl
 - 30-120°C Adjustable thermostat
 - 8 Lt Boiling capacity
 - Adjustable legs
 - Long life
 - Using over bench



GAST-6MH40

- FR**
- Boitier en acier inoxydable
 - Nettoyage facile
 - Hygiénique
 - Vanne évacuatrice
 - Bac monobloc
 - Thermostat réglable 30°C- 120°C
 - Capacité de friture a 8l
 - Pied soutien réglable
 - Longue durée de vie
 - Utilisable sur planche

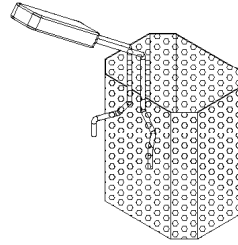

KOD CODE	EBATLAR DIMENSIONS	FİYAT PRICE
GAST-67.MKN.SPT.06	138 x 106 x 164	48 €

SOS BENMARI / SAUCE BAIN-MARIE / SAUCE BAIN-MARIE



- TR**
- Paslanmaz çelik gövde
 - Gastronom küvetlere uygun hazne
 - Hijyenik
 - 30-120°C termostat kontrollü
 - Yekpare havuz
 - Ayarlanabilir ayaklar
 - Kolay temizlenebilir
 - Set üstü olarak kullanılır.
 - Tahliye vanası

- FR**
- Boitier en acier inoxydable
 - Cuvette gastronomique a réservoir
 - Hygiénique
 - Contrôle thermostat 30°C- 120°C
 - Bac massive
 - Pieds soutien réglable
 - Nettoyage facile
 - Utilisable sur planche

- EN**
- Stainless steel body
 - Reservoir available gastronom cups
 - Hygienic
 - Temperature adjustment from 30°C to 120°C
 - Monoblock bowl
 - Adjustable legs
 - Easy to Clean
 - Using over bench
 - Drainage pipe

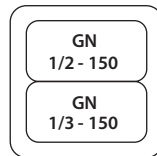

GAST-6SBM40

KOD CODE	MODEL DESCRIPTION	EBATLAR DIMENSIONS	LİTRE LITER	KG KG	GÜÇ POWER	ENERJİ ENERGY	FİYAT PRICE
GAST-6MH40	40 lık Makarna Haşlama Pasta Cooker	400 x 630 x 300	8 Lt.	19 Kg.	6 kW	400 V 3 ~ 60 Hz	925 €
GAST-6SBM40	40 lık Sosbenmari Sauce Bain-Marie	400 x 630 x 300	-	17 Kg.	2,5 kW	230 V ~ 50 Hz	595 €

PATATES DİNLENDİRME / HEATED CHIPS UNIT / REPOSE POMME DE TERRE



- TR**
- Paslanmaz çelik gövde
 - Ayarlanabilir ayaklar
 - Kolay temizlenebilir
 - Set üstü olarak kullanılır

- EN**
- Stainless steel body
 - Adjustable legs
 - Easy to clean
 - Using over bench

- FR**
- Boîtier en acier inoxydable
 - Pieds réglable
 - Nettoyage facile
 - Utilisation sur planche



GAST-6PDE40

KOD CODE	MODEL DESCRIPTION	EBATLAR DIMENSIONS	KG KG	GÜÇ POWER	ENERJİ ENERGY	FİYAT PRICE
GAST-6PDE40	Patates Dinlendirme Heated Chips Unit	400 x 630 x 300	16 Kg.	0,75 kW	230 V ~ 50 Hz	540 €

NÖTR TEZGAHLAR / WORKING BENCHS / COMPTOIR NEUTRES



GAST-6NT40



GAST-6NT80

KOD CODE	MODEL DESCRIPTION	EBATLAR DIMENSIONS	KG KG	GÜÇ POWER	ENERJİ ENERGY	FİYAT PRICE
GAST-6NT40	40 lık Nötr Tezgah Working Bench	400 x 630 x 300	10 Kg.	-	-	275 €
GAST-6NT60	60 lık Nötr Tezgah Working Bench	600 x 630 x 300	14 Kg.	-	-	310 €
GAST-6NT80	80 lık Nötr Tezgah Working Bench	800 x 630 x 300	20 Kg.	-	-	365 €

40 LİK DOLAP / CUPBOARD / ARMOIRE

- TR**
- Paslanmaz çelik gövde
 - Uzun ömürlü
 - Çarpma kapılı
 - 63'lük seri bütün cihazlara uyumlu
 - Ayarlanabilir ayaklar



GAST-6DP40

60 LİK DOLAP / CUPBOARD / ARMOIRE

- EN**
- Stainless steel body
 - Long life
 - With slam door
 - 63 series compatible with all devices
 - Adjustable feet



GAST-6DP60

80 LİK DOLAP / CUPBOARD / ARMOIRE

- FR**
- Corps en acier inoxydable
 - Longue durée de vie
 - Avec porte à clapet
 - Série 63 compatible avec tous les appareils
 - Pieds réglables



GAST-6DP80

KOD CODE	MODEL DESCRIPTION	EBATLAR DIMENSIONS	KG KG	GÜÇ POWER	ENERJİ ENERGY	FİYAT PRICE
GAST-6DP40	40 lık Dolap Cupboard	400 x 630 x 550	15 Kg.	-	-	335 €
GAST-6DP60	60 lık Dolap Cupboard	600 x 630 x 550	19 Kg.	-	-	395 €
GAST-6DP80	80 lık Dolap Cupboard	800 x 630 x 550	24 Kg.	-	-	455 €

60 LİK GAZLI KUZİNE / GAS RANGE / CUISINIÈRE A GAZ



- TR**
- Paslanmaz çelik gövde
 - Emniyet ventilli valf
 - Alev denetleme tertibatı
 - LPG ve Doğalgaza uyumlu
 - Yekpare üst tablalı
 - Piezoelektrik ateşlemeli, pilotlu fırın
 - Termostat kontrollü fırın 100-300°C arası ayarlanabilir
 - Fırın ölçüleri 30x45 tepsiye göre
 - İzolasyonlu fırın
 - Tel raf (1 adet)
 - Ayarlanabilir ayaklar

- EN**
- Stainless steel body
 - Safety gas valve with thermocouple
 - Fire inspect system
 - Heavy duty top cast iron
 - Available LPG or Natural Gas
 - Easy to clean
 - Piezoelectric ignition and pilot flame
 - Oven thermostat adjustment between 100°C to 300°C
 - Oven size is 30x45
 - Isolated oven
 - Removable wire tray size GN 1/1
 - Adjustable legs

- FR**
- Boîtier en acier inoxydable
 - Thermo couple
 - Dispositif du contrôle feu
 - Compatible avec GPL / gaz naturel
 - Plancher brûleur mono bloc
 - Pilote d'allumage Pié-électrique
 - Contrôle thermostat du four (100°C- 300°C)
 - Dimension du four-plateau four (30 45)
 - Four isolé
 - Grille 1 pièce
 - Pieds réglable



GAST-6KZG60

KOD CODE	MODEL DESCRIPTION	EBATLAR DIMENSIONS	KG KG	GÜÇ POWER	DG SARFIYAT N.GAS EXPENDITURE	BASINÇ PRESSURE	FİYAT PRICE
GAST-6KZG60	4 lü Kuzine Gas Range With 4 Burners	600 x 630 x 850	96 Kg.	24 kW	2,54 m ³	20 mbar	1.885 €

A close-up, black and white photograph of a stainless steel kitchen hood. The hood has a brushed metal finish. In the center, the word "GAST" is embossed in a large, bold, sans-serif font. The lighting creates highlights and shadows on the metal surface, emphasizing the texture and the three-dimensional quality of the embossed logo. The background is slightly blurred, showing the curved top of the hood and some mechanical details.

GAST

700 LÜK SERİ
700 SERIES / Série des 700





700 LÜK SERİ
700 SERIES
Série des 700

40 LİK TEKLİ ELEKTRİKLİ FRİTÖZ / ELECTRIC FRYER WITH 1 BASKET / FRITEUSE ELECTRIQUE



- TR**
- Paslanmaz çelik gövde
 - Hareketli ısıtıcılar sayesinde kolay temizlik
 - Hijyenik
 - Tahliye vanası
 - Yekpare bankolu havuz
 - Emniyet termostatu
 - 100-180°C ayarlı termostat
 - 12 lt kızartma kapasiteli
 - Ayarlanabilir ayaklar
 - Uzun ömürlü
 - Set üstü ve dolaplı kullanıma uygundur

**GAST-7FE40**

- EN**
- Stainless steel body
 - Easy to clean
 - Hygienic
 - With drainage pipe
 - Monoblock bowl
 - Safety thermostat
 - 100-180°C Adjustable thermostat
 - 12 lt frying capacity
 - Adjustable legs
 - Long life
 - Available use over bench or with cupboard

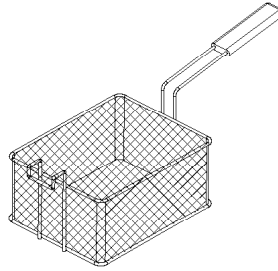

KOD CODE	EBATLAR DIMENSIONS	FİYAT PRICE
GAST-7EFSPT.02	208 x 263 x 122	30 €

80 LİK ÇİFTLİ ELEKTRİKLİ FRİTÖZ / ELECTRIC FRYER WITH 2 BASKETS / FRITEUSE ELECTRIQUE



- FR**
- Boîtier en acier inoxydable
 - Nettoyage facile avec chauffage mobile
 - Hygiénique
 - Soupape d'évacuation
 - Bac monobloc
 - Thermostat de sécurité
 - Thermostat réglable (100°C- 180°C)
 - Capacité friture a 12l
 - Pieds réglable
 - Longévité
 - Utilisable sur planche ou armoire

**GAST-7FE80**

KOD CODE	MODEL DESCRIPTION	EBATLAR DIMENSIONS	LİTRE LITER	KG KG	GÜÇ POWER	ENERJİ ENERGY	FİYAT PRICE
GAST-7FE40	40 lık Tekli Elektrikli Fritöz Electric Fryer with 1 Basket	400 x 700 x 300	12 Lt.	17 Kg.	9 kW	400 V 3 ~ 60 Hz	1.070 €
GAST-7FE80	80 lık Çiftli Elektrikli Fritöz Electric Fryer with 2 Baskets	800 x 700 x 300	12+12 Lt.	39 Kg.	18 kW	400 V 3 ~ 60 Hz	1.680 €

40 LİK TEKLİ ELEKTRİKLİ DİJİTAL FRİTÖZ / ELECTRIC DIGITAL FRYER WITH 1 BASKET / FRITEUSE ELECTRIQUE DIGITAL   

- TR**
- Paslanmaz çelik gövde
 - Hareketli ısıtıcılar sayesinde kolay temizlik
 - Hijyenik
 - Tahliye vanası
 - Yekpare bankolu havuz
 - Emniyet termostadı
 - 100-180°C ayarlı dijital termostat
 - 12 lt kızartma kapasiteli
 - Ayarlanabilir ayaklar
 - Uzun ömürlü
 - Set üstü ve dolaplı kullanıma uygundur



GAST-7FED40

- EN**
- Stainless steel body
 - Easy to clean
 - Hygienic
 - With drainage pipe
 - Monoblock bowl
 - Safety thermostat
 - 100-180°C Adjustable digital thermostat
 - 12 Lt frying capacity
 - Adjustable legs
 - Long life
 - Available use over bench or with cupboard

80 LİK TEKLİ ELEKTRİKLİ DİJİTAL FRİTÖZ / ELECTRIC DIGITAL FRYER WITH 2 BASKETS / FRITEUSE ELECTRIQUE DIGITAL   

- FR**
- Boîtier en acier inoxydable
 - Nettoyage facile avec chauffage mobile
 - Hygiénique
 - Soupape d'évacuation
 - Bac monobloc
 - Thermostat de sécurité
 - Thermostat réglable digital (100c-180c)
 - Capacité friture a 12l
 - Pieds réglable
 - Longévité
 - Utilisable sur planche ou armoire



GAST-7FED80

KOD CODE	MODEL DESCRIPTION	EBATLAR DIMENSIONS	LİTRE LITER	KG KG	GÜÇ POWER	ENERJİ ENERGY	FİYAT PRICE
GAST-7FED40	40 lık Tekli Elektrikli Dijital Fritöz Electric Digital Fryer With 1 Basket	400 x 700 x 300	12 Lt.	17 Kg.	9 kW	400 V 3 ~ 60 Hz	1.320 €
GAST-7FED80	80 lık Çiftli Elektrikli Dijital Fritöz Electric Digital Fryer With 2 Baskets	800 x 700 x 300	12+12 Lt.	39 Kg.	18 kW	400 V 3 ~ 60 Hz	2.180 €

40 LİK GAZLI FRİTÖZ / GAS FRYER WITH 1 BASKET / FRITEUSE A GAZ



- TR**
- Paslanmaz çelik gövde
 - Piezoelektrik ateşlemeli pilot
 - LPG ve Doğalgaza uyumlu
 - Yekpare bankolu havuz
 - Emniyet termostati
 - 100°C-180°C ısı kontrolü
 - 15 lt yağ kapasitesi
 - Ayarlanabilir ayak

- EN**
- Stainless steel body
 - Safety gas thermostat 100°C-180°C
 - Piezoelectric ignition and pilot flame
 - Available LPG or Natural Gas
 - Monoblock bowl
 - 15 lt frying capacity
 - Adjustable legs



GAST-7FG40

80 LİK GAZLI FRİTÖZ / GAS FRYER WITH 2 BASKETS / FRITEUSE A GAZ



- FR**
- Adaptable à fonctionner au GPL ou GN.
 - Commande thermostatique.
 - Panier en acier inoxydable.
 - Robinet de sécurité magnétique.
 - Vanne de vidange d'huile
 - Sécurité du thermostat contre la surchauffe.
 - Nettoyage facile grâce à la conception hygiénique.
 - Corps en acier inoxydable



GAST-7FG80

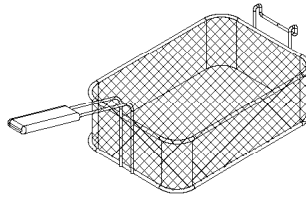

KOD CODE	EBATLAR DIMENSIONS	FİYAT PRICE
GAST-7GFSPT.05	232 x 312 x 100	32 €

KOD CODE	MODEL DESCRIPTION	EBATLAR DIMENSIONS	LİTRE LITER	KG KG	GÜÇ POWER	DG SARFIYAT N.GAS EXPENDITURE	BASINÇ PRESSURE	FİYAT PRICE
GAST-7FG40	40 lık Gazlı Fritöz Gas Fryer with 1 Basket	400 x 700 x 850	15 Lt.	42 Kg.	7 kW	0,74 m ³	20 mbar	1.705 €
GAST-7FG80	80 lık Gazlı Fritöz Gas Fryer with 2 Baskets	800 x 700 x 850	15+15 Lt.	68 Kg.	14 kW	1,48 m ³	20 mbar	2.670 €

40 LİK ELEKTRİKLİ MAKARNA HAŞLAMA / ELECTRIC PASTA COOKER / CUISEUR À PATE ELECTRIQUE   

- TR**
- Paslanmaz çelik gövde
 - Kolay temizlenebilir
 - Hijyenik
 - Tahliye vanası
 - Yekpare havuz
 - 30-120°C ayarlı termostat
 - 12 lt kaynatma kapasitesi
 - Ayarlanabilir ayaklar
 - Uzun ömürlü
 - Setüstü ve dolaplı kullanıma uygundur.

- EN**
- Stainless steel body
 - Easy to clean
 - Hygienic
 - Drainage pipe
 - Monoblock bowl
 - 30°C-180°C Adjustable thermostat
 - 12 lt boiling capacity
 - Adjustable legs
 - Long life
 - Available use over bench or with cupboard

- FR**
- Boîtier en acier inoxydable
 - Nettoyage facile
 - Hygiénique
 - Soupape d'évacuation
 - Bac monobloc
 - Thermostat réglable 30°C-120°C
 - Capacité de friture 12 lt
 - Pieds réglable
 - Longévité
 - Utilisable sur planche ou armoire



GAST-7MH40

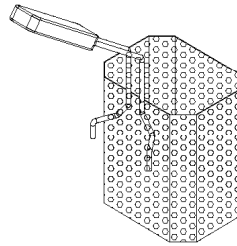

KOD CODE	EBATLAR DIMENSIONS	FİYAT PRICE
GAST-67.MKN.SPT.06	138 x 106 x 164	48 €

KOD CODE	MODEL DESCRIPTION	EBATLAR DIMENSIONS	LİTRE LITER	KG KG	GÜÇ POWER	ENERJİ ENERGY	FİYAT PRICE
GAST-7MH40	40 lık Elektrikli Makarna Haşlama Single Electric Pasta Cooker	400 x 700 x 300	12 Lt.	22 Kg.	6 kW	400 V 3 ~ 60 Hz	1.040 €

40 LİK GAZLI MAKARNA HAŞLAMA / GAS PASTA COOKER / CUISEUR À PATE ELECTRIQUE   

- TR**
- Paslanmaz çelik gövde
 - Piezoelektrik ateşlemeli pilot
 - LPG ve Doğalgaza uyumlu
 - Alev denetleme tertibatı pilot yanış sistemi
 - Kolay temizlenebilir
 - Hijyenik
 - Tahliye vanası
 - Yekpare havuz
 - 26 lt kaynatma kapasitesi
 - Ayarlanabilir ayaklar
 - Uzun ömürlü

- EN**
- Stainless steel body
 - Piezoelectric ignition and pilot flame
 - Fire inspect system
 - Easy to clean
 - Hygienic
 - Drainage pipe
 - Monoblock bowl
 - 26 lt boiling capacity
 - Adjustable legs
 - Long life

- FR**
- Boîtier en acier inoxydable
 - Commande thermostatique.
 - Panier en acier inoxydable.
 - Dispositif de surveillance de flamme
 - Nettoyage facile
 - Hygiénique
 - Soupape d'évacuation
 - Bac monobloc
 - Capacité de friture 26 lt
 - Pieds réglable
 - Longévité



GAST-7MHG40

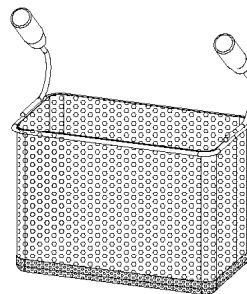

KOD CODE	EBATLAR DIMENSIONS	FİYAT PRICE
GAST-7G.MKN.SPT.06-INOX	280 x 148 x 203	220 €

KOD CODE	MODEL DESCRIPTION	EBATLAR DIMENSIONS	LİTRE LITER	KG KG	GÜÇ POWER	DG SARFIYAT N.GAS EXPENDITURE	BASINÇ PRESSURE	FİYAT PRICE
GAST-7MHG40	40 lık Gazlı Makarna Haşlama Single Gas Pasta Cooker	400 x 700 x 850	26 Lt.	36 Kg.	8,5 kW	0,89 m ³	20 mbar	2.705 €

2 Lİ ELEKTRİKLİ OCAK / ELECTRIC COOKER WITH 2 HOT PLATES / CUISINIÈRE ELECTRIQUE A 2 PLAQUES CHAUFFANTES



- TR**
- Paslanmaz çelik gövde
 - Pik dökümlü 20-23 cm pleytler
 - 3 kademeli kontrol edilebilir
 - Ayarlanabilir ayaklar
 - Kolay temizlenebilir
 - Set üstü ve dolaplı kullanıma uygun



GAST-70CE40

4 LÜ ELEKTRİKLİ OCAK / ELECTRIC COOKER WITH 4 HOT PLATES / CUISINIÈRE ELECTRIQUE A 4 PLAQUES CHAUFFANTES



- EN**
- Stainless steel body
 - 20-23 cm diameter of heaters
 - Adjustable control system
 - Adjustable legs
 - Easy to clean
 - Available use over bench or with cupboard

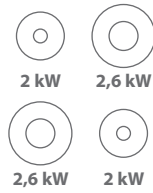

GAST-70CE80

6 Lİ ELEKTRİKLİ OCAK / ELECTRIC COOKER WITH 6 HOT PLATES / CUISINIÈRE ELECTRIQUE A 6 PLAQUES CHAUFFANTES



- FR**
- Boîtier en acier inoxydable
 - Les plates de fonte à 20 cm
 - Contrôle à 3 niveaux graduels
 - Pieds soutien réglable
 - Nettoyage facile
 - Utilisable sur planche



GAST-70CE120

KOD CODE	MODEL DESCRIPTION	EBATLAR DIMENSIONS	KG KG	GÜÇ POWER	ENERJİ ENERGY	FİYAT PRICE
GAST-70CE40	2 li Elektrikli Ocak Electric Cooker With 2 Hot Plates	400 x 700 x 300	15 Kg.	4,6 kW	400 V 3 ~ 60 Hz	605 €
GAST-70CE80	4 lü Elektrikli Ocak Electric Cooker With 4 Hot Plates	800 x 700 x 300	32 Kg.	9,2 kW	400 V 3 ~ 60 Hz	985 €
GAST-70CE120	6 lı Elektrikli Ocak Electric Cooker With 6 Hot Plates	1200 x 700 x 300	60 Kg.	13,8 kW	400 V 3 ~ 60 Hz	1.335 €

2 Lİ GAZLI OCAK / GAS COOKER WITH 2 BURNERS / CUISINIÈRE GAZ A 2 BRÛLEURS   

- TR**
- Paslanmaz çelik gövde
 - Emniyet ventilli valf
 - Alev denetleme tertibatı pilot yanış sistemi
 - Sanayi tipi döküm
 - LPG ve Doğalgaza uyumlu
 - Ayarlanabilir ayaklar
 - Kolay temizlenebilir
 - Set üstü ve dolaplı kullanıma uygundur



GAST-70CG240

4 LÜ GAZLI OCAK / GAS COOKER WITH 4 BURNERS / CUISINIÈRE GAZ A 4 BRÛLEURS   

- EN**
- Stainless steel body
 - Safety gas valve with thermocouple
 - Fire inspect system
 - Heavy duty top cast iron
 - Available LPG or Natural Gas
 - Adjustable legs
 - Easy to clean
 - Available use over bench or with cupboard



GAST-70CG480

6 LI GAZLI OCAK / GAS COOKER WITH 6 BURNERS / CUISINIÈRE GAZ A 6 BRÛLEURS   

- FR**
- Boitier en acier inoxydable
 - Thermocouple
 - Dispositif de surveillance de flamme
 - Fonte de type industriel
 - Compatible au GPL / gaz naturel
 - Nettoyage facile
 - Utilisable sur planche ou armoire



GAST-70CG6120

KOD CODE	MODEL DESCRIPTION	EBATLAR DIMENSIONS	KG KG	GÜÇ POWER	DG SARFIYAT N.GAS EXPENDITURE	BASINÇ PRESSURE	FİYAT PRICE
GAST-70CG240	2 li Gazlı Ocak Gas Cooker With 2 Burners	400 x 700 x 300	24 Kg.	10 kW	1,05 m ³	20 mbar	765 €
GAST-70CG480	4 lü Gazlı Ocak Gas Cooker With 4 Burners	800 x 700 x 300	44 Kg.	20 kW	2,11 m ³	20 mbar	1.255 €
GAST-70CG6120	6 lı Gazlı Ocak Gas Cooker With 6 Burners	1200 x 700 x 300	57 Kg.	30 kW	3,17 m ³	20 mbar	1.825 €

40 LİK ELEKTRİKLİ IZGARA / ELECTRIC GRILL PLATE / GRILL ELECTRIQUE



- TR**
- Paslanmaz çelik gövde
 - Pişirme yüzeyi düz, yarı yollu ve tam yollu olarak 3 model
 - Pişirme yüzeyi 50-300°C arası ayarlanabilir
 - Ayarlanabilir ayaklar
 - Homojen pişirme yüzeyi
 - Yağ toplama kanalı, boşaltma çekmecesini
 - Kolay temizlenebilir
 - Set üstü olarak kullanılır



GAST-7PIE40YO

- EN**
- Stainless steel body
 - Types of cooking plate (smooth, 1/2 nervour and nervour)
 - Thermostat adjustment between 50-300°C
 - Adjustable legs
 - Equal temperature distribution on the cooking surface
 - Fat collecting drawer
 - Easy to clean
 - Using over bench

80 LİK ELEKTRİKLİ IZGARA / ELECTRIC GRILL PLATE / GRILL ELECTRIQUE



- FR**
- Boîtier en acier inoxydable
 - 3 Modèles de cuisson, surface lisse, demi rainuré ou rainuré
 - Surface de cuisson réglable (50°C-300°C)
 - Pieds réglable
 - Surface de cuisson homogène
 - Canal de collecte de graisse-Tiroir dècharge
 - Nettoyage facile
 - Utilisable sur planche ou armoire



GAST-7PIE80YO

KOD CODE	MODEL DESCRIPTION	EBATLAR DIMENSIONS	KG KG	GÜÇ POWER	ENERJİ ENERGY	FİYAT PRICE	FİYAT PRICE	FİYAT PRICE
GAST-7PIE40	40 lık Elektrikli Izgara Electric Grill Plate	400 x 700 x 300	41 Kg.	4,5 kW	400 V 3 ~ 60 Hz	795 €	805 €	810 €
GAST-7PIE80	80 lık Elektrikli Izgara Electric Grill Plate	800 x 700 x 300	72 Kg.	9 kW	400 V 3 ~ 60 Hz	1.375 €	1.385 €	1.400 €

GAST-7PIE40
GAST-7PIE80GAST-7PIE40YO
GAST-7PIE80YOGAST-7PIE40TO
GAST-7PIE80TO

40 LİK ELEKTRİKLİ KROM IZGARA / ELECTRIC CHROME GRILL PLATES / GRILL ELECTRIQUE CHROME   

- TR**
- Paslanmaz çelik gövde
 - Pişirme yüzeyi düz, yarı oluklu ve tam oluklu olarak 3 model
 - Krom pişirme yüzeyi
 - Pişirme yüzeyi 50-300°C arası ayarlanabilir
 - Ayarlanabilir ayaklar
 - Homojen pişirme yüzeyi
 - Yağ toplama kanalı, boşaltma çekmecesini
 - Kolay temizlenebilir
 - Set üstü olarak kullanılır



GAST-7PIKE40YO

- EN**
- Stainless steel body
 - Types of cooking plate (smooth, 1/2 nervour and nervour)
 - Chrome cooking surface
 - Thermostat adjustment between 50-300°C
 - Adjustable legs
 - Equal temperature distribution on the cooking surface
 - Fat collecting drawer
 - Easy to clean
 - Using over bench

80 LİK ELEKTRİKLİ KROM IZGARA / ELECTRIC CHROME GRILL PLATES / GRILL ELECTRIQUE CHROME   

- FR**
- Boîtier en acier inoxydable
 - 3 Modèles de cuisson, surface lisse, demi rainuré ou rainuré
 - Cuisson chrome
 - Surface de cuisson réglable (50°C-300°C)
 - Pieds réglable
 - Surface de cuisson homogène
 - Canal de collecte de graisse-Tiroir décharge
 - Nettoyage facile
 - Utilisable sur planche ou armoire



GAST-7PIKE80YO

KOD CODE	MODEL DESCRIPTION	EBATLAR DIMENSIONS	KG KG	GÜÇ POWER	ENERJİ ENERGY	FİYAT PRICE	FİYAT PRICE	FİYAT PRICE
GAST-7PIKE40	40 lık Elektrikli Izgara Krom Electric Plate Chrome	400 x 700 x 300	41 Kg.	4,5 kW	400 V 3 ~ 60 Hz	1.280 €	1.370 €	1.390 €
GAST-7PIKE80	80 lık Elektrikli Izgara Krom Electric Grill Plate Chrome	800 x 700 x 300	72 Kg.	9 kW	400 V 3 ~ 60 Hz	2.140 €	2.275 €	2.310 €



GAST-7PIKE40



GAST-7PIKE40YO



GAST-7PIKE40TO



GAST-7PIKE80

GAST-7PIKE80YO

GAST-7PIKE80TO

40 LİK GAZLI IZGARA / GAS GRILL PLATE / GRILL A GAZ



- TR**
- Paslanmaz çelik gövde
 - LPG ve Doğalgaza uyumlu
 - Pişirme yüzeyi düz, yarı oluklu ve tam oluklu olarak 3 model
 - 80'lik modellerde ayrı ayrı kontrol edilebilen pişirme yüzeyi
 - Piezoelektrik ateşlemeli, pilotlu
 - Ayarlanabilir ayaklar
 - Homojen pişirme yüzeyi
 - Yağ toplama kanalı, boşaltma çekmecesini
 - Kolay temizlenebilir
 - Setüstü ve dolaplı kullanıma uygundur.



GAST-7PIG40YO

- EN**
- Stainless steel body
 - Available LPG or Natural Gas
 - Types of cooking plate (smooth, 1/2 nervour and nervour)
 - 80 cm models have double independent cooking zone by two gas valves
 - Piezoelectric ignition, pilot flame
 - Adjustable legs
 - Equal temperature distribution on the cooking surface
 - With removable fat collecting drawer
 - Easy to clean
 - Available use over bench or with cupboard

80 LİK GAZLI IZGARA / GAS GRILL PLATE / GRILL A GAZ



- FR**
- Boîtier en acier inoxydable
 - 3 Modèles de cuisson, surface lisse, demi rainuré ou rainuré
 - Contrôle de cuisson séparable sur surface plate / modèle 80
 - Surface de cuisson réglable
 - Pieds réglable
 - Surface de cuisson homogène
 - Canal de collecte de graisse -Tiroir d'évacuation
 - Nettoyage facile
 - Utilisable sur planche ou armoire



GAST-7PIG80YO

KOD CODE	MODEL DESCRIPTION	EBATLAR DIMENSIONS	KG KG	GÜÇ POWER	DG SARFIYAT N.GAS EXPENDITURE	BASINÇ PRESSURE	FİYAT PRICE	FİYAT PRICE	FİYAT PRICE
GAST-7PIG40	40 lık Gazlı Izgara Gas Grill Plate	400 x 700 x 300	41 Kg.	7 kW	0,73 m ³	20 mbar	755 €	765 €	775 €
GAST-7PIG80	80 lık Gazlı Izgara Gas Grill Plate	800 x 700 x 300	71 Kg.	14 kW	1,46 m ³	20 mbar	1.335 €	1.350 €	1.360 €



GAST-7PIG40

GAST-7PIG80



GAST-7PIG40YO GAST-7PIG40TO

GAST-7PIG80YO GAST-7PIG80TO

40 LİK GAZLI KROM IZGARA / GAS CHROME GRILL PLATE / GRILL A GAZ CHROME

- TR**
- Paslanmaz çelik gövde
 - LPG ve Doğalgaza uyumlu
 - Krom pişirme yüzeyi
 - Pişirme yüzeyi düz, yarı oluklu ve tam oluklu olarak 3 model
 - 80'lik modellerde ayrı ayrı kontrol edilebilen pişirme yüzeyi
 - Piezoelektrik ateşlemeli, pilotlu
 - Ayarlanabilir ayaklar
 - Homojen pişirme yüzeyi
 - Yağ toplama kanalı, boşaltma çekmecesini
 - Kolay temizlenebilir
 - Setüstü ve dolaplı kullanıma uygundur.

**GAST-7PIG40KYO**

- EN**
- Stainless steel body
 - Available LPG or Natural Gas
 - Chrome cooking surface
 - Types of cooking plate (smooth, 1/2 nervour and nervour)
 - 80 cm models have double indepented cooking zone by two gas valves
 - Piezoelectric ignition, pilot flame
 - Adjustable legs
 - Equal temperature distribution on the cooking surface
 - With removable fat collecting drawer
 - Easy to clean
 - Available use over bench or with cupboard

80 LİK GAZLI KROM IZGARA / GAS CHROME GRILL PLATE / GRILL A GAZ CHROME

- FR**
- Boitier en acier inoxydable
 - 3 Modèles de cuisson, surface lisse, demi rainuré ou rainuré
 - Cuisson chrome
 - Contrôle de cuisson séparable sur surface plate / modèle 80
 - Surface de cuisson réglable
 - Pieds réglable
 - Surface de cuisson homogène
 - Canal de collecte de graisse–Tiroir décharge
 - Nettoyage facile
 - Utilisable sur planche ou armoire

**GAST-7PIG80KYO**

KOD CODE	MODEL DESCRIPTION	EBATLAR DIMENSIONS	KG KG	GÜÇ POWER	DG SARFIYAT N.GAS EXPENDITURE	BASINÇ PRESSURE	FİYAT PRICE	FİYAT PRICE	FİYAT PRICE
GAST-7PIG40K	40 lık Gazlı Izgara Krom Gas Grill Plate Chrome	400 x 700 x 300	41 Kg.	7 kW	0,73 m ³	20 mbar	1.230 €	1.320 €	1.340 €
GAST-7PIG80K	80 lık Gazlı Izgara Krom Gas Grill Plate Chrome	800 x 700 x 300	71 Kg.	14 kW	1,46 m ³	20 mbar	1.945 €	2.080 €	2.120 €

GAST-7PIG40K
GAST-7PIG80K

GAST-7PIG40KYO
GAST-7PIG80KYO

GAST-7PIG40KTO
GAST-7PIG80KTO

40 LİK LAVATAŞ IZGARA / LAVASTONE GRILL / GRILL A PIERRE DE LAVE



- TR**
- Paslanmaz çelik gövde
 - Emniyet ventilli valf
 - Pilot alevi
 - LPG ve Doğalgaza uyumlu
 - Yağ toplama kanalı, boşaltma çekmecesini
 - Ayarlanabilir ayaklar
 - Kolay temizlenebilir
 - Set üstü olarak kullanılır



GAST-7LIG40

- EN**
- Stainless steel body
 - Safety gas valve with thermocouple
 - Pilot flame
 - Available LPG or Natural Gas
 - Fat collecting drawer
 - Adjustable legs
 - Easy to clean
 - Using over bench

80 LİK LAVATAŞ IZGARA / LAVASTONE GRILL / GRILL A PIERRE DE LAVE



- FR**
- Boîtier en acier inoxydable
 - Thermo couple
 - Pilot d'allumage
 - Compatible au GPL et gaz naturel
 - Canal de collecte de graisse-Tiroir décharge
 - Pieds réglable
 - Nettoyage facile
 - Utilisable sur planche ou armoire



GAST-7LIG80

KOD CODE	MODEL DESCRIPTION	EBATLAR DIMENSIONS	KG KG	GÜÇ POWER	DG SARFIYAT N.GAS EXPENDITURE	BASINÇ PRESSURE	FİYAT PRICE
GAST-7LIG40	40 lık Lavataş Izgara Lavastone Grill	400 x 700 x 300	43 Kg.	7 kW	0,73 m ³	20 mbar	900 €
GAST-7LIG80	80 lık Lavataş Izgara Lavastone Grill	800 x 700 x 300	75 Kg.	14 kW	1,46 m ³	20 mbar	1.260 €

DG-40

LPG-41

DG-80

LPG-81

40 LİK DÖKÜM IZGARA / CAST IRON GRILL / GRILL EN FONTE



- TR**
- Paslanmaz çelik gövde
 - Emniyet ventilli valf
 - Pilot alevi
 - LPG ve Doğalgaza uyumlu
 - Su haznesi ile ürünü nemlendirme özelliği
 - Döküm pişirme yüzeyi
 - Ayarlanabilir ayaklar
 - Kolay temizlenebilir
 - Setüstü ve dolaplı kullanıma uygundur



GAST-7DIG40

80 LİK DÖKÜM IZGARA / CAST IRON GRILL / GRILL EN FONTE



- EN**
- Stainless steel body
 - Safety gas valve with thermocouple
 - Pilot flame
 - Available LPG or Natural Gas
 - Water drawers
 - Cast iron surface
 - Fat collecting drawer
 - Adjustable legs
 - Easy to clean
 - Available use over bench or with cupboard



GAST-7DIG80

120 LİK DÖKÜM IZGARA / CAST IRON GRILL / GRILL EN FONTE



- FR**
- Boîtier en acier inoxydable
 - Thermo couple
 - Pilote d'alumage
 - Compatible au GPL et Gas Naturel
 - Réservoir d'eau humidifié le produit
 - Indicateur du niveau d'eau
 - Surface de cuisson en fer
 - Pieds réglable
 - Nettoyage facile
 - Utilisable sur planche ou armoire



GAST-7DIG120

KOD CODE	MODEL DESCRIPTION	EBATLAR DIMENSIONS	KG KG	GÜÇ POWER	DG SARFIYAT N.GAS EXPENDITURE	BASINÇ PRESSURE	FİYAT PRICE
GAST-7DIG40	40 lık Döküm Izgara Cast Iron Grill	400 x 750 x 350	50 Kg.	8 kW	0,84 m ³	20 mbar	1.155 €
GAST-7DIG80	80 lık Döküm Izgara Cast Iron Grill	800 x 750 x 350	95 Kg.	16 kW	1,69 m ³	20 mbar	1.575 €
GAST-7DIG120	120 lık Döküm Izgara Cast Iron Grill	1200 x 750 x 350	156 Kg.	24 kW	2,54 m ³	20 mbar	2.075 €

DG-40	LPG-41
DG-80	LPG-81
DG-120	LPG-121

50 LİK ÇUBUKLU IZGARA / PIPE GRILL / GRILL A BARRE



- TR**
- Paslanmaz çelik gövde
 - Özel dizayn edilmiş ısıtıcılar
 - Hareketli ısıtıcılar sayesinde kolay temizlik
 - Sıcak su haznesi
 - Ürünü kurutmadan pişirme özelliği
 - Özel ısı ayarlı termostatik sistem
 - Tahliye vanası
 - Ayarlanabilir ayaklar
 - Setüstü ve dolaplı kullanıma uygundur.



GAST-7CIG50

80 LİK ÇUBUKLU IZGARA / PIPE GRILL / GRILL A BARRE



- EN**
- Stainless steel body
 - Special heating system
 - Moving heat system provides easy cleaning
 - Steam function
 - Temperature adjust with termostatic special system
 - Drainage pipe
 - Adjustable legs
 - Available use over bench or with cupboard



GAST-7CIG80

120 LİK ÇUBUKLU IZGARA / PIPE GRILL / GRILL A BARRE



- FR**
- Boîtier en acier inoxydable
 - Chauffage spécialement conçu
 - Nettoyage facile grâce au chauffage mobile
 - Réservoir d'eau chaude
 - Caractéristique de cuisson sans sécher le produit
 - Système spécial réglage thermostatique de la chaleur
 - Soupape d'évacuation
 - Pieds réglable
 - Utilisable sur planche ou armoire



GAST-7CIG120

KOD CODE	MODEL DESCRIPTION	EBATLAR DIMENSIONS	KG KG	GÜÇ POWER	ENERJİ ENERGY	FİYAT PRICE
GAST-7CIG50	50 lik Çubuklu Izgara Pipe Grill	500 x 700 x 300	30 Kg.	4 kW	230V ~ 50 Hz	1.625 €
GAST-7CIG80	80 lik Çubuklu Izgara Pipe Grill	800 x 700 x 300	47 Kg.	6,5 kW	400 V 3 ~ 60 Hz	2.150 €
GAST-7CIG120	120 lik Çubuklu Izgara Pipe Grill	1200 x 700 x 300	96 Kg.	9,5 kW	400 V 3 ~ 60 Hz	2.670 €

40 LİK DOLAP / CUPBOARD / ARMOIRE

- TR**
- Paslanmaz çelik gövde
 - Uzun ömürlü
 - Çarpma kapılı
 - 70'lik seri bütün cihazlara uyumlu
 - Ayarlanabilir ayaklar



GAST-7DP40

80 LİK DOLAP / CUPBOARD / ARMOIRE

- EN**
- Stainless steel body
 - Long life
 - Available 70 series products
 - Adjustable legs



GAST-7DP80

120 LİK DOLAP / CUPBOARD / ARMOIRE

- FR**
- Boîtier en acier inoxydable
 - Longévité
 - Portes battantes
 - Série 70 est compatible à tous les appareils
 - Pieds réglable



GAST-7DP120

KOD CODE	MODEL DESCRIPTION	EBATLAR DIMENSIONS	KG KG	FİYAT PRICE
GAST-7DP40	40 lik Dolap Cupboard	400 x 700 x 550	14 Kg.	350 €
GAST-7DP80	80 lik Dolap Cupboard	800 x 700 x 550	22 Kg.	480 €
GAST-7DP120	120 lik Dolap Cupboard	1200 x 700 x 550	30 Kg.	650 €

PATATES DİNLENDİRME / HEATED CHIPS UNIT / REPOSE POMME DE TERRE



- TR**
- Paslanmaz çelik gövde
 - Ayarlanabilir ayaklar
 - Kolay temizlenebilir
 - Setüstü ve dolaplı kullanıma uygundur.

- FR**
- Boîtier en acier inoxydable
 - Pieds réglables
 - Nettoyage facile
 - Utilisation sur planche ou armoire

- EN**
- Stainless steel body
 - Adjustable legs
 - Easy to clean
 - Available use over bench or with cupboard



GAST-7PDE40

KOD CODE	MODEL DESCRIPTION	EBATLAR DIMENSIONS	LİTRE LITER	KG KG	GÜÇ POWER	ENERJİ ENERGY	FİYAT PRICE
GAST-7PDE40	Patates Dinlendirme Heated Chips Unit	400 x 700 x 300	-	17 Kg.	0,75 kW	230 V ~ 50 Hz	570 €

40 LİK NÖTR TEZGAH / WORKING BENCH / COMPTOIR NEUTRE



GAST-7NT40

80 LİK NÖTR TEZGAH / WORKING BENCH / COMPTOIR NEUTRE



GAST-7NT80

KOD CODE	MODEL DESCRIPTION	EBATLAR DIMENSIONS	KG KG	FİYAT PRICE
GAST-7NT40	40 lık Nötr Tezgah Working Bench	400 x 700 x 300	10 Kg.	330 €
GAST-7NT80	80 lık Nötr Tezgah Working Bench	800 x 700 x 300	20 Kg.	410 €

40 LİK BENMARİ / BAIN-MARIE / CAISSEUR SAUCE BAIN-MARIE



- TR**
- Paslanmaz çelik gövde
 - Gastronom küvetlere uygun hazne
 - Hijyenik
 - Tahliye vanası
 - 30-120°C termostat kontrollü
 - Yekpare havuz
 - Ayarlanabilir ayaklar
 - Kolay temizlenebilir
 - Setüstü ve dolaplı kullanıma uygundur.



GAST-7BM40

- EN**
- Stainless steel body
 - Hygienic
 - One piece reservoir
 - Temperature adjustment from 30°C to 120°C
 - Monoblock bowl
 - Adjustable legs
 - Easy to clean
 - Available use over bench or with cupboard

80 LİK BENMARİ / BAIN-MARIE / CAISSEUR SAUCE BAIN-MARIE



- FR**
- Boîtier en acier inoxydable
 - Hygiénique
 - Soupape d'évacuation
 - Thermostat contrôleur cuisson (30°C-120°C)
 - Bac monobloc
 - Pieds réglables
 - Nettoyage facile
 - Utilisable sur planche ou armoire



GAST-7BM80

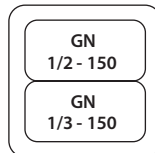

KOD CODE	MODEL DESCRIPTION	EBATLAR DIMENSIONS	KG KG	GÜÇ POWER	ENERJİ ENERGY	FİYAT PRICE
GAST-7BM40	40 lık Benmari Bain-Marie	400 x 700 x 300	16 Kg.	2,5 kW	230 V ~ 50 Hz	690 €
GAST-7BM80	80 lık Benmari Bain-Marie	800 x 700 x 300	31 Kg.	3,5 kW	230 V ~ 50 Hz	925 €

4 LÜ ELEKTRİKLİ KUZİNE / ELECTRIC RANGE WITH 4 HOT PLATES / CUISINIÈRE ELECTRIQUE   

- TR**
- Paslanmaz çelik gövde
 - Pik dökümlü 23 cm pleytler
 - 3 kademeli kontrol edilebilir
 - Fırın ölçüleri GN 1/1 göre
 - Fırın sıcaklığı 50°C-300°C arası ayarlanabilir
 - Fırın içi rezistanslar alt ve üst olarak ayrı ayrı kontrol edilir
 - İzolasyonlu fırın
 - Seyyar GN 1/1 tel raf
 - Ayarlanabilir ayaklar

- EN**
- Stainless steel body
 - 23 cm diameter heaters
 - Adjustable control system
 - Oven size is GN 1/1
 - Oven thermostat adjustment between 50°C to 300°C
 - Oven heaters work separately or together
 - Isolated oven
 - Removable wire tray size GN 1/1
 - Adjustable legs

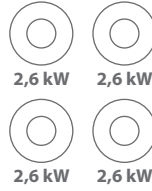

GAST-7KZ80

6 LI ELEKTRİKLİ KUZİNE / ELECTRIC RANGE WITH 6 HOT PLATES / CUISINIÈRE ELECTRIQUE   

- FR**
- Boitier en acier inoxydable
 - Plate de fonte de 23 cm
 - Réglable à 3 niveaux
 - Mesures du four d'après GN 1/1
 - Température du four réglable (50°C-300°C)
 - Résistance du four contrôlable pour cuisson séparable haut et bas
 - Four isolé
 - Grille mobile GN 1/1
 - Pieds réglable



GAST-7KZ120

KOD CODE	MODEL DESCRIPTION	EBATLAR DIMENSIONS	KG KG	GÜÇ POWER	ENERJİ ENERGY	FİYAT PRICE
GAST-7KZ80	4 lü Elektrikli Kuzine Electric Range With 4 Hot Plates	800 x 700 x 850	118 Kg.	15,4 kW	400 V 3 ~ 60 Hz	2.165 €
GAST-7KZ120	6 li Elektrikli Kuzine Electric Range With 6 Hot Plates	1200 x 700 x 850	140 Kg.	20,6 kW	400 V 3 ~ 60 Hz	2.670 €

4 LÜ GAZLI KUZİNE / GAS RANGE 4 WITH BURNERS / CUISINIÈRE A GAZ



TR

- Paslanmaz çelik gövde
- Emniyet ventilli valf
- Alev denetleme tertibatı
- Sanayi tipi döküm
- LPG ve Doğalgaza uyumlu
- Kolay temizlenebilir pislik tepsisi
- Piezoelektrik ateşlemeli, pilotlu
- Termostat kontrollü fırın 100-300°C arası ayarlanabilir
- Fırın ölçüleri GN 2/1 göre
- İzolasyonlu fırın
- Seyyar GN 2/1 tel raf
- Ayarlanabilir ayaklar

EN

- Stainless steel body
- Safety gas valve with thermocouple
- Fire inspect system
- Heavy duty top cast iron
- Available LPG or Natural Gas
- Easy to clean
- Piezoelectric ignition and pilot flame
- Oven thermostat adjustment between 100°C to 300°C
- Oven size is GN 2/1
- Isolated oven
- Removable wire tray size GN 2/1
- Adjustable legs



GAST-7KZG470

6 LI GAZLI KUZİNE / GAS RANGE 6 WITH BURNERS / CUISINIÈRE A GAZ



FR

- Boîtier en acier inoxydable
- Thermo couple
- Dispositif du contrôle de feu
- Fonte de type industriel
- Compatible au GPL- Gaz Naturel
- Nettoyage facile de la saleté du plateau
- Pilote d'allumage piézo-électrique
- Thermostat contrôle cuisson (100°C-300°C)
- Dimension du four selon GN 2/1
- Four isolé
- Grille mobile GN 2/1
- Pieds réglable



GAST-7KZG670

KOD CODE	MODEL DESCRIPTION	EBATLAR DIMENSIONS	KG KG	GÜÇ POWER	DG SARFIYAT N.GAS EXPENDITURE	BASINÇ PRESSURE	FİYAT PRICE
GAST-7KZG470	4 lü Gazlı Kuzine Gas Range With 4 Burners	800 x 700 x 850	130 Kg.	25,9 kW	2,042 m ³	20 mbar	2.330 €
GAST-7KZG670	6 lü Gazlı Kuzine Gas Range With 6 Burners	1200 x 700 x 850	150 Kg.	35,9 kW	2,831 m ³	20 mbar	2.905 €

KAYNATMA KAZANI (ENDİREKT ISITMA) / BOILING PAN (INDIRECT HEATING) / MARMITE (INDIRECT)   

TR

- Paslanmaz çelik gövde
- Karşı ağırlıklı kapak
- Brülör komple magnet ventili
- Magnet mentil ateşleme ve stop butonları ile pilotlu termokulplu ve termostatlı
- Alev sönünce gaz kesme
- Soğuk-sıcak su doldurma musluğu
- Boşaltma musluğu

EN

- Stainless steel body
- Counterweighted folding lid
- Burner with complete magnet security valve
- Which contains ignition and stop button together with pilot thermocouple
- Cold and hot water filling cock
- Drainage cock



FR

- Contrôle de la valve sous-préssion avec le manomètre.
- Robinet de remplissage d'eau chaude et froide.
- Robinet de drainage.
- Clapet de surcharge.
- Bac avec double casseroles.
- Nettoyage facile grâce à la conception hygiénique.
- Corps en acier inoxydable.

GAST-7KT80

KOD CODE	MODEL DESCRIPTION	EBATLAR DIMENSIONS	LİTRE LITER	KG KG	GÜÇ POWER	ENERJİ ENERGY	FİYAT PRICE
GAST-7KT80	Elektrikli Kaynatma Tenceresi Electric Boiling Pan	800 x 700 x 850	80 Lt.	134 Kg.	18 kW	400 V 3 ~ 60 Hz	4.780 €
GAST-7KTG80	Gazlı Kaynatma Tenceresi Gas Boiling Pan	800 x 700 x 850	80 Lt.	175 Kg.	20 kW	400 V 3 ~ 60 Hz	4.780 €

DEVİRİLİR TAVA / TILTING BRATT PAN / SAUTEUSES BASCULANTE



TR

- Gövde, panel, tava paslanmaz çelik
- Kaldırma mekanizması el ile çalışır
- Paslanmaz çelik brülör ateşlemeli, pilotlu termokulplu ve termostatlı
- Alev sönerse gaz kesilir
- LPG ve Doğalgaza uyumludur
- Cihaz üstündeki musluk ile doldurma ve yıkama yapmak kolaydır

EN

- Body, panelling and pan made of stainless steel
- The tilting mechanism is manual operated
- Stainless steel burner with ignition, pilot thermocouple and thermostat
- If the flame goes out, gas are cutted off
- Operable with LPG and Natural Gas
- Filling with faucet on top of device and washing is easy



GAST-7DTG80

FR

- Système de levage manuel.
- Clapet de surcharge.
- Interrupteur de sécurité.
- Nettoyage facile grâce à la conception hygiénique.
- Construction en acier inoxydable.

KOD CODE	MODEL DESCRIPTION	EBATLAR DIMENSIONS	LİTRE LITER	KG KG	GÜÇ POWER	ENERJİ ENERGY	FİYAT PRICE
GAST-7DT80	Elektrikli Devrilir Tava Electric Tilting Bratt Pan	800 x 700 x 850	50 Lt.	160 Kg.	12 kW	400 V 3 ~ 60 Hz	3.960 €
GAST-7DTG80	Gazlı Devrilir Tava Gas Tilting Bratt Pan	800 x 700 x 850	50 Lt.	125 Kg.	18 kW	400 V 3 ~ 60 Hz	3.960 €

2 Lİ KARE ELEKTRİKLİ OCAK / ELECTRIC COOKER WITH 2 SQUARE HOT PLATES / CUISINIÈRE ELECTRIQUE A 2 CARRÉ PLQUE CHAUFFANTES



- TR**
- Paslanmaz çelik gövde
 - Pik dökümlü 22x22 cm pleytler
 - 6 kademeli kontrol edilebilir
 - Ayarlanabilir ayaklar
 - Kolay temizlenebilir
 - Set üstü ve dolaplı kullanıma uygun



GAST-70CE240

4 LÜ KARE ELEKTRİKLİ OCAK / ELECTRIC COOKER WITH 4 SQUARE HOT PLATES / CUISINIÈRE ELECTRIQUE A 4 CARRÉ PLQUE CHAUFFANTES



- EN**
- Stainless steel body
 - 22x22 cm diameter of heaters
 - Adjustable control system
 - Adjustable legs
 - Easy to clean
 - Available use over bench or with cupboard



GAST-70CE480

6 Lİ KARE ELEKTRİKLİ OCAK / ELECTRIC COOKER WITH 6 SQUARE HOT PLATES / CUISINIÈRE ELECTRIQUE A 6 CARRÉ PLQUE CHAUFFANTES



- FR**
- Boîtier en acier inoxydable
 - Les plates de fonte à 22 cm
 - Contrôle à 6 niveaux graduels
 - Pieds soutien réglable
 - Nettoyage facile
 - Utilisable sur planche



GAST-70CE6120

KOD CODE	MODEL DESCRIPTION	EBATLAR DIMENSIONS	KG KG	GÜÇ POWER	ENERJİ ENERGY	FİYAT PRICE
GAST-70CE240	2 li Kare Elektrikli Ocak Electric Cooker With 2 Hot Plates	400 x 700 x 300	15 Kg.	5,2 kW	400 V 3 ~ 60 Hz	1.070 €
GAST-70CE480	4 lü Kare Elektrikli Ocak Electric Cooker With 4 Hot Plates	800 x 700 x 300	32 Kg.	10,4 kW	400 V 3 ~ 60 Hz	1.865 €
GAST-70CE6120	6 lı Kare Elektrikli Ocak Electric Cooker With 6 Hot Plates	1200 x 700 x 300	60 Kg.	15,6 kW	400 V 3 ~ 60 Hz	2.640 €

4 LÜ KARE ELEKTRİKLİ KUZİNE / ELECTRIC RANGE WITH 4 SQUARE HOT PLATES / CUISINIÈRE ELECTRIQUE A CARRÉ PLAQUE CHAUFFANTES



- TR**
- Paslanmaz çelik gövde
 - Pik dökümlü 22x22 cm pleytler
 - 6 kademeli kontrol edilebilir
 - Fırın ölçüleri GN 1/1 göre
 - Fırın sıcaklığı 50°C-300°C arası ayarlanabilir
 - Fırın içi rezistanslar alt ve üst olarak ayrı ayrı kontrol edilir
 - İzolasyonlu fırın
 - Seyyar GN 1/1 tel raf
 - Ayarlanabilir ayaklar

- EN**
- Stainless steel body
 - 22x22 cm diameter heaters
 - Adjustable control system
 - Oven size is GN 1/1
 - Oven thermostat adjustment between 50°C to 300°C
 - Oven heaters work separately or together
 - Isolated oven
 - Removable wire tray size GN 1/1
 - Adjustable legs

- FR**
- Boîtier en acier inoxydable
 - Plate de fonte de 22 cm
 - Réglable à 6 niveaux
 - Mesures du four d'après GN 1/1
 - Température du four réglable (50°C-300°C)
 - Résistance du four contrôlable pour cuisson séparable haut et bas
 - Four isolé
 - Grille mobile GN 1/1
 - Pieds réglable



GAST-7KZ480

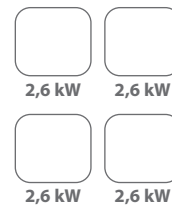

GAST-7KZ670

KOD CODE	MODEL DESCRIPTION	EBATLAR DIMENSIONS	KG KG	GÜÇ POWER	ENERJİ ENERGY	FİYAT PRICE
GAST-7KZ480	4 lü Kare Elektrikli Kuzine Electric Range With 4 Hot Plates	800 x 700 x 850	118 Kg.	15,4 kW	400 V 3 ~ 60 Hz	2.895 €
GAST-7KZ670	6 lü Kare Elektrikli Kuzine Electric Range With 6 Hot Plates	1200 x 700 x 850	140 Kg.	20,6 kW	400 V 3 ~ 60 Hz	3.835 €

KAPALI ATEŞ ELEKTİRLİ KUZİNE / SOLID TOP ELECTRIC / CUISINIÈRE ELECTRIQUE A FONTE



TR

- Paslanmaz çelik gövde
- Pişirme yüzeyi 15mm ST52 Pleyt
- 4 bölge kontrol edilebilen pişirme yüzeyi
- Fırın ölçüleri GN 1/1 göre
- Fırın sıcaklığı 50°C-300°C arası ayarlanabilir
- Fırın içi rezistanslar alt ve üst olarak ayrı ayrı kontrol edilir
- İzolasyonlu fırın
- Seyyar GN 1/1 tel raf
- Ayarlanabilir ayaklar

EN

- Stainless steel body
- Type of cooking plate 15mm ST52
- Cooking surface able to control by 4 independent zones
- Oven size is GN 1/1
- Oven thermostat adjustment between 50°C to 300°C
- Oven heaters work separately or together
- Isolated oven
- Removable wire tray size GN 1/1
- Adjustable legs

FR

- Boîtier en acier inoxydable
- Surface de cuisson plate 15mm ST52
- Surface de cuisson contrôlable à 4 zones indépendants
- Mesures du four d'après GN 1/1
- Température du four réglable (50°C-300°C)
- Résistance du four contrôlable pour cuisson séparable haut et bas
- Four isolé
- Grille mobile GN 1/1
- Pieds réglable



GAST-7KKZ80

KOD CODE	MODEL DESCRIPTION	EBATLAR DIMENSIONS	KG KG	GÜÇ POWER	ENERJİ ENERGY	FİYAT PRICE
GAST-7KKZ80	Kapalı Ateş Elektrikli Kuzine Solid Top Electric With Oven	800 x 700 x 850	118 Kg.	17 kW	400 V 3 ~ 60 Hz	3.020 €
GAST-7KKZ800	Kapalı Ateş Elektrikli Ocak Solid Top Electric	800 x 700 x 850	118 Kg.	12 kW	400 V 3 ~ 60 Hz	1.945 €

KAPALI ATEŞ GAZLI KUZİNE / SOLID TOP GAS / CUISINIÈRE GAZ A FONTE



TR

- Paslanmaz çelik gövde
- 3 parçalı sanayi tip döküm yüzey
- Emniyet ventilli valf
- Alev denetleme tertibatı
- Sanayi tipi döküm
- LPG ve Doğalgaza uyumlu
- Kolay temizlenebilir pislik tepsisi
- Piezoelektrik ateşlemeli, pilotlu
- Termostat kontrollü fırın 100-300°C arası ayarlanabilir
- Fırın ölçüleri GN 2/1 göre
- İzolasyonlu fırın
- Seyyar GN 2/1 tel raf
- Ayarlanabilir ayaklar

EN

- Stainless steel body
- 3 pieces heavy duty cast iron
- Safety gas valve with thermocouple
- Fire inspect system
- Heavy duty top cast iron
- Available LPG or Natural Gas
- Easy to clean
- Piezoelectric ignition and pilot flame
- Oven thermostat adjustment between 100°C to 300°C
- Oven size is GN 2/1
- Isolated oven
- Removable wire tray size GN 2/1
- Adjustable legs

FR

- Boîtier en acier inoxydable
- 3 pièces en fonte robuste
- Thermo couple
- Dispositif du contrôle de feu
- Fonte de type industriel
- Compatible au GPL- Gaz Naturel
- Nettoyage facile de la saleté du plateau
- Pilote d'allumage piézo-électrique
- Thermostat contrôle cuisson (100°C-300°C)
- Dimension du four selon GN 2/1
- Four isolé
- Grille mobile GN 2/1
- Pieds réglable



GAST-7KKZG80

KOD CODE	MODEL DESCRIPTION	EBATLAR DIMENSIONS	KG KG	GÜÇ POWER	DG SARFIYAT N.GAS EXPENDITURE	BASINÇ PRESSURE	FİYAT PRICE
GAST-7KKZG80	Kapalı Ateş Gazlı Kuzine Solid Top Gas With Oven	800 x 700 x 850	130 Kg.	10,5 kW	1,09 m ³	20 mbar	2.640 €
GAST-7KKZG800	Kapalı Ateş Gazlı Ocak Solid Top Gas	800 x 700 x 850	130 Kg.	5,5 kW	0,57 m ³	20 mbar	1.975 €

930 LUK SERİ
930 SERIES / Série des 930



930 LUK SERİ
930 SERIES
Série des 930



40 LİK TEKLİ ELEKTRİKLİ FRİTÖZ / ELECTRIC FRYER WITH 1 BASKET / FRITEUSE ELECTRIQUE



TR

- Paslanmaz çelik gövde
- Hareketli ısıtıcılar sayesinde kolay temizlik
- Hijyenik
- Tahliye vanası
- Yekpare bankolu havuz
- Emniyet termostatu
- 100-180°C ayarlı termostat
- 24+24 litre kızartma kapasitesi
- Ayarlanabilir ayaklar
- Uzun ömürlü

EN

- Stainless steel body
- Easy to clean
- Hygienic
- With drainage pipe
- Monoblock baskets
- Safety thermostat
- 100-180°C Adjustable thermostat
- 24 Lt frying capacity for each bowls
- Adjustable legs
- Long life



GAST-9FE40

80 LİK ÇİFTLİ ELEKTRİKLİ FRİTÖZ / ELECTRIC FRYER WITH 2 BASKETS / FRITEUSE ELECTRIQUE



FR

- Panier en acier inoxydable.
- L'élément de chauffage mobile permet une maintenance facile.
- Vanne de vidange d'huile.
- Commande thermostatique.
- Sécurité de la surchauffe avec thermostat.
- Nettoyage facile grâce à la conception hygiénique.
- Corps en acier inoxydable



GAST-9FE80

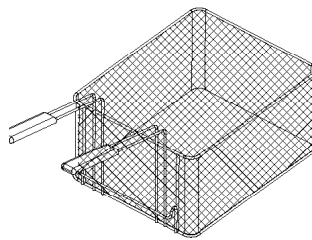

KOD CODE	EBATLAR DIMENSIONS	FİYAT PRICE
GAST-9EGFSPT.09	300 x 370 x 185	38 €

KOD CODE	MODEL DESCRIPTION	EBATLAR DIMENSIONS	LİTRE LITER	KG KG	GÜÇ POWER	ENERJİ ENERGY	FİYAT PRICE
GAST-9FE40	Tekli Elektrikli Fritöz Electric Fryer With 1 Basket	400 x 930 x 850	24 Lt.	50 Kg.	16,5 kW	400 V 3 ~ 60 Hz	1.630 €
GAST-9FE80	Çiftli Elektrikli Fritöz Electric Fryer With 2 Baskets	800 x 930 x 850	24+24 Lt.	93 Kg.	33 kW	400 V 3 ~ 60 Hz	2.580 €

40 LİK TEKLİ GAZLI FRİTÖZ / GAS FRYER WITH 1 BASKET / FRITEUSE A GAZ



- TR**
- Paslanmaz çelik gövde
 - Piezoelektrik ateşlemeli pilot
 - LPG ve Doğalgaza uyumlu
 - Hareketli ısıtıcılar sayesinde kolay temizlik
 - Hijyenik
 - Tahliye vanası
 - Yekpare bankolu havuz
 - Emniyet termostatu
 - 100-180°C ayarlı termostat
 - 24 litre kızartma kapasitesi
 - Ayarlanabilir ayaklar
 - Uzun ömürlü

- EN**
- Stainless steel body
 - Safety gas thermostat 100°C-180°C
 - Piezoelectric ignition and pilot flame
 - Easy to clean
 - Hygienic
 - With drainage pipe
 - Monoblock basket
 - Safety thermostat
 - 100-180°C Adjustable thermostat
 - 24 Lt frying capacity for each bowls
 - Adjustable legs
 - Long life



GAST-9FG40

930 SERIES

80 LİK ÇİFTLİ GAZLI FRİTÖZ / GAS FRYER WITH 2 BASKETS / FRITEUSE A GAZ



- FR**
- Adaptable à fonctionner au GPL ou GN.
 - Commande thermostatique.
 - Panier en acier inoxydable.
 - Lelement de chauffage mobile permet une maintenance facile.
 - Vanne de vidange d'huile.
 - Commande thermostatique.
 - Sécurité de la surchauffe avec thermostat.
 - Nettoyage facile grâce à la conception hygiénique.
 - Corps en acier inoxydable



GAST-9FG80

KOD CODE	EBATLAR DIMENSIONS	FİYAT PRICE
GAST-9EGFSPT.09	300 x 370 x 185	38 €

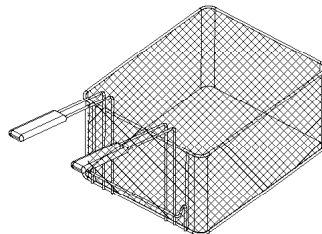

KOD CODE	MODEL DESCRIPTION	EBATLAR DIMENSIONS	LİTRE LITER	KG KG	GÜÇ POWER	DG SARFIYAT N.GAS EXPENDITURE	BASINÇ PRESSURE	FİYAT PRICE
GAST-9FG40	Tekli Gazlı Fritöz Gas Fryer With 1 Basket	400 x 930 x 850	24 Lt.	75 Kg.	12 kW	1,27 m ³	20 mbar	2.025 €
GAST-9FG80	Çiftli Gazlı Fritöz Gas Fryer With 2 Baskets	800 x 930 x 850	24+24 Lt.	117 Kg.	24 kW	2,54 m ³	20 mbar	3.005 €

2 Lİ ELEKTRİKLİ OCAK / ELECTRIC COOKER WITH 2 HOT PLATES / CUISINIÈRE ELECTRIQUE

- TR**
- Paslanmaz çelik gövde
 - Pik dökümlü 30x30 cm 4 kW pleytler
 - 6 Kademeli kontrol edilebilir
 - Kolay temizlenebilir
 - Ayarlanabilir ayaklar
 - Uzun ömürlü



GAST-90CE240

4 LÜ ELEKTRİKLİ OCAK / ELECTRIC COOKER WITH 4 HOT PLATES / CUISINIÈRE ELECTRIQUE

- EN**
- Stainless steel body
 - 30x30 cm 4 kW hot plates
 - 6 levels of switch control
 - Adjustable legs
 - Easy to clean
 - Long life



GAST-90CE480

6 Lİ ELEKTRİKLİ OCAK / ELECTRIC COOKER WITH 6 HOT PLATES / CUISINIÈRE ELECTRIQUE

- FR**
- Boîtier en acier inoxydable.
 - Dimension fontes 30x30 cm plaques 4 kw.
 - Contrôlable a 6 niveaux.
 - Pieds réglable



GAST-90CE6120

KOD CODE	MODEL DESCRIPTION	EBATLAR DIMENSIONS	KG KG	GÜÇ POWER	ENERJİ ENERGY	FİYAT PRICE
GAST-90CE240	2 li Elektrikli Ocak Electric Cooker With 2 Hot Plates	400 x 930 x 850	65 Kg.	8 kW	400 V 3 ~ 60 Hz	1.700 €
GAST-90CE480	4 lü Elektrikli Ocak Electric Cooker With 4 Hot Plates	800 x 930 x 850	97 Kg.	16 kW	400 V 3 ~ 60 Hz	2.895 €
GAST-90CE6120	6 lı Elektrikli Ocak Electric Cooker With 6 Hot Plates	1200 x 930 x 850	135 Kg.	24 kW	400 V 3 ~ 60 Hz	3.725 €

2 Lİ GAZLI OCAK / GAS COOKER WITH 2 BURNERS / CUISINIÈRE A GAZ



TR

- Paslanmaz çelik gövde
- Emniyet ventilli valf
- Alev denetleme tertibatı
- Pilot yanış sistemi
- Sanayi tipi döküm
- LPG ve Doğalgaza uyum
- Kolay temizlenebilir
- Ayarlanabilir ayaklar
- Uzun ömürlü



GAST-90CG240

4 LÜ GAZLI OCAK / GAS COOKER WITH 4 BURNERS / CUISINIÈRE A GAZ



EN

- Stainless steel body
- Safety gas valve with thermocouple
- Fire inspect system
- Heavy duty top cast iron
- Available LPG and Natural Gas
- Adjustable legs
- Easy to clean
- Long life



GAST-90CG480

6 LI GAZLI OCAK / GAS COOKER WITH 6 BURNERS / CUISINIÈRE A GAZ



FR

- Adaptable à fonctionner au GPL et GN.
- Soupape de sécurité magnétique.
- La fonte supérieur permet une excellente résistance aux chocs.
- Nettoyage facile grâce à la conception hygiénique.



GAST-90CG6120

KOD CODE	MODEL DESCRIPTION	EBATLAR DIMENSIONS	KG KG	GÜÇ POWER	DG SARFIYAT N.GAS EXPENDITURE	BASINÇ PRESSURE	FİYAT PRICE
GAST-90CG240	2 li Gazlı Ocak Gas Cooker With 2 Burners	400 x 930 x 850	70 Kg.	16 kW	1,69 m ³	20 mbar	1.285 €
GAST-90CG480	4 lü Gazlı Ocak Gas Cooker With 4 Burners	800 x 930 x 850	100 Kg.	32 kW	3,38 m ³	20 mbar	2.025 €
GAST-90CG6120	6 lı Gazlı Ocak Gas Cooker With 6 Burners	1200 x 930 x 850	142 Kg.	48 kW	5,07 m ³	20 mbar	2.640 €

40 LİK ELEKTRİKLİ PLEYT IZGARA / ELECTRIC GRILL PLATE / GRILL ELECTRIQUE



- TR**
- Paslanmaz çelik gövde
 - Pişirme yüzeyi düz, yarı oluklu ve tam oluklu
 - 80'lik modellerde ayrı ayrı kontrol edilebilen pişirme yüzeyi
 - 50-300°C termostat
 - Homojen pişirme yüzeyi
 - Yağ toplama kanalı, boşaltma çekmecesini
 - Ayarlanabilir ayaklar
 - Uzun ömürlü



GAST-9PIE40YO

80 LİK ELEKTRİKLİ PLEYT IZGARA / ELECTRIC GRILL PLATE / GRILL ELECTRIQUE



- EN**
- Stainless steel body
 - Types of cooking plate (smooth, 1/2 nervour and nervour)
 - Thermostat adjustment between 50-300°C
 - Equal temperature distribution on the cooking surface
 - Fat collecting drawer
 - Adjustable legs
 - Long life



GAST-9PIE80YO

- FR**
- Boîtier en acier inoxydable
 - 3 Modèles de cuisson, surface lisse, demi rainuré ou rainuré
 - Contrôle de cuisson séparable sur surface plate 1 modèle 80
 - Surface de cuisson réglable (50°C-300°C)
 - Pieds réglable
 - Surface de cuisson homogène
 - Canal de collecte de graisse- Tiroir décharge
 - Nettoyage facile
 - Utilisable sur planche ou armoire

KOD CODE	MODEL DESCRIPTION	EBATLAR DIMENSIONS	KG KG	GÜÇ POWER	ENERJİ ENERGY	FİYAT PRICE	FİYAT PRICE	FİYAT PRICE
GAST-9PIE40	40 lık Elektrikli Izgara Electric Grill Plate	400 x 930 x 850	86 Kg.	7 kW	400 V 3 ~ 60 Hz	1.360 €	1.375 €	1.385 €
GAST-9PIE80	80 lık Elektrikli Izgara Electric Grill Plate	800 x 930 x 850	150 Kg.	14 kW	400 V 3 ~ 60 Hz	2.010 €	2.025 €	2.045 €



GAST-9PIE40



GAST-9PIE40YO

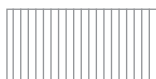

GAST-9PIE40TO



GAST-9PIE80

GAST-9PIE80YO

GAST-9PIE80TO

40 LİK ELEKTRİKLİ KROM PLEYT IZGARA / ELECTRIC CHROME GRILL PLATE / GRILL ELECTRIQUE CHROME



- TR**
- Paslanmaz çelik gövde
 - Pişirme yüzeyi düz, yarı oluklu ve tam oluklu
 - Krom pişirme yüzeyi
 - 80'lik modellerde ayrı ayrı kontrol edilebilen pişirme yüzeyi
 - 50-300°C termostat
 - Homojen pişirme yüzeyi
 - Yağ toplama kanalı, boşaltma çekmecesi
 - Ayarlanabilir ayaklar
 - Uzun ömürlü



GAST-9PIKE40YO

80 LİK ELEKTRİKLİ KROM PLEYT IZGARA / ELECTRIC CHROME GRILL PLATE / GRILL ELECTRIQUE CHROME



- EN**
- Stainless steel body
 - Types of cooking plate (smooth, 1/2 nervour and nervour)
 - Chrome cooking surface
 - Thermostat adjustment between 50-300°C
 - Equal temperature distribution on the cooking surface
 - Fat collecting drawer
 - Adjustable legs
 - Long life



GAST-9PIKE80YO

- FR**
- Boîtier en acier inoxydable
 - 3 Modèles de cuisson, surface lisse, demi rainuré ou rainuré
 - Cuisson chrome
 - Contrôle de cuisson séparable sur surface plate 1 modèle 80
 - Surface de cuisson réglable (50°C-300°C)
 - Pieds réglable
 - Surface de cuisson homogène
 - Canal de collecte de graisse- Tiroir décharge
 - Nettoyage facile
 - Utilisable sur planche ou armoire

KOD CODE	MODEL DESCRIPTION	EBATLAR DIMENSIONS	KG KG	GÜÇ POWER	ENERJİ ENERGY	FİYAT PRICE	FİYAT PRICE	FİYAT PRICE
GAST-9PIKE40	40 lık Elektrikli Krom Izgara Electric Chrome Grill Plate	400 x 930 x 850	86 Kg.	7 kW	400 V 3 ~ 60 Hz	2.025 €	2.145 €	2.260 €
GAST-9PIKE80	80 lık Elektrikli Krom Izgara Electric Chrome Grill Plate	800 x 930 x 850	150 Kg.	14 kW	400 V 3 ~ 60 Hz	3.120 €	3.295 €	3.360 €



GAST-9PIKE40

GAST-9PIKE80



GAST-9PIKE40YO

GAST-9PIKE80YO



GAST-9PIKE40TO

GAST-9PIKE80TO



40 LİK PLEYT GAZLI IZGARA / GAS GRILL PLATE / GRILL A GAZ



- TR**
- Paslanmaz çelik gövde
 - Pişirme yüzeyi düz, yarı oluklu ve tam oluklu
 - 80'lik modellerde ayrı ayrı kontrol edilebilen pişirme yüzeyi
 - Homojen pişirme yüzeyi
 - Yağ toplama kanalı, boşaltma çekmecesini
 - Ayarlanabilir ayaklar
 - Uzun ömürlü
 - LPG ve Doğalgaza uyumlu
 - Piezoelektrik ateşlemeli, pilotlu



GAST-9PIG40YO

80 LİK PLEYT GAZLI IZGARA / GAS GRILL PLATE / GRILL A GAZ



- EN**
- Stainless steel body
 - Types of cooking plate (smooth, 1/2 nervour and nervour)
 - 80 cm models have double independent cooking zone
 - Equal temperature distribution on the cooking surface
 - Fat collecting drawer
 - Adjustable legs
 - Long life
 - Available LPG and Natural Gas
 - Piezoelectric ignition, pilot flame

- FR**
- Boîtier en acier inoxydable
 - 3 Modèles de cuisson, surface lisse, demi rainuré ou rainuré
 - Contrôle de cuisson séparable sur surface plate 1 modèle 80
 - Pieds réglable
 - Surface de cuisson homogène
 - Canal de collecte de graisse- Tiroir décharge
 - Nettoyage facile
 - Utilisable sur planche ou armoire



GAST-9PIG80YO

KOD CODE	MODEL DESCRIPTION	EBATLAR DIMENSIONS	KG KG	GÜÇ POWER	DG SARFIYAT N.GAS EXPENDITURE	BASINÇ PRESSURE	FİYAT PRICE	FİYAT PRICE	FİYAT PRICE
GAST-9PIG40	40 lık Gazlı Izgara Gas Plate Grill	400 x 930 x 850	75 Kg.	8 kW	0,94 m ³	20 mbar	1.290 €	1.305 €	1.315 €
GAST-9PIG80	80 lık Gazlı Izgara Gas Plate Grill	800 x 930 x 850	146 Kg.	16 kW	1,87 m ³	20 mbar	1.875 €	1.895 €	1.925 €



GAST-9PIG40

GAST-9PIG80



GAST-9PIG40YO

GAST-9PIG80YO



GAST-9PIG40TO

GAST-9PIG80TO



40 LİK PLEYT GAZLI KROM IZGARA / GAS CHROME GRILL PLATE / GRILL A GAZ CHROME



TR

- Paslanmaz çelik gövde
- Pişirme yüzeyi düz, yarı oluklu ve tam oluklu
- Krom pişirme yüzeyi
- 80'lik modellerde ayrı ayrı kontrol edilebilen pişirme yüzeyi
- Homojen pişirme yüzeyi
- Yağ toplama kanalı, boşaltma çekmecesini
- Ayarlanabilir ayaklar
- Uzun ömürlü
- LPG ve Doğalgaza uyumlu
- Piezoelektrik ateşlemeli, pilotlu



GAST-9PIKG40YO

80 LİK PLEYT GAZLI KROM IZGARA / GAS CHROME GRILL PLATE / GRILL A GAZ CHROME



EN

- Stainless steel body
- Types of cooking plate (smooth, 1/2 nervour and nervour)
- Chrome cooking surface
- 80 cm models have double indepented cooking zone
- Equal temperature distribution on the cooking surface
- Fat collecting drawer
- Adjustable legs
- Long life
- Available LPG and Natural Gas
- Piezoelectric ignition, pilot flame

FR

- Boîtier en acier inoxydable
- 3 Modèles de cuisson, surface lisse, demi rainuré ou rainuré
- Cuisson chrome
- Contrôle de cuisson séparable sur surface plate 1 modèle 80
- Pieds réglable
- Surface de cuisson homogène
- Canal de collecte de graisse- Tiroir décharge
- Nettoyage facile
- Utilisable sur planche ou armoire



GAST-9PIKG80YO

KOD CODE	MODEL DESCRIPTION	EBATLAR DIMENSIONS	KG KG	GÜÇ POWER	DG SARFIYAT N.GAS EXPENDITURE	BASINÇ PRESSURE	FİYAT PRICE	FİYAT PRICE	FİYAT PRICE
GAST-9PIKG40	40 lık Gazlı Krom Izgara Gas Chrome Plate Grill	400 x 930 x 850	75 Kg.	8 kW	0,73 m ³	20 mbar	1.875 €	1.995 €	2.110 €
GAST-9PIKG80	80 lık Gazlı Krom Izgara Gas Chrome Plate Grill	800 x 930 x 850	146 Kg.	16 kW	1,46 m ³	20 mbar	2.920 €	3.095 €	3.160 €



GAST-9PIKG40

GAST-9PIKG80



GAST-9PIKG40YO

GAST-9PIKG80YO



GAST-9PIKG40TO

GAST-9PIKG80TO



40 LİK LAVATAŞ IZGARA / LAVASTONE GRILL / GRILL A PIERRE DE LAVE



- TR**
- Paslanmaz çelik gövde
 - Emniyet ventilli valf
 - Alev denetleme tertibatı
 - Piezoelektrik ateşlemeli, pilotlu
 - LPG ve Doğalgaza uyumlu
 - Yağ toplama kanalı, boşaltma çekmecesini
 - Ayarlanabilir ayaklar
 - Kolay temizlenebilir
 - Uzun ömürlü



GAST-9LIG40

80 LİK LAVATAŞ IZGARA / LAVASTONE GRILL / GRILL A PIERRE DE LAVE



- EN**
- Stainless steel body
 - Safety gas valve with thermocouple
 - Fire inspect system
 - Piezoelectric ignition, pilot flame
 - Available LPG and Natural Gas
 - Fat collecting drawer
 - Adjustable legs
 - Easy to clean
 - Long life



GAST-9LIG80

- FR**
- Boitier en acier
 - Thermo couple
 - Pilote d'allumage piézo-électrique
 - Compatible au GPL et gaz naturel
 - Canal de collecte de graisse-Tiroir de décharge
 - Pieds réglable
 - Nettoyage facile
 - Utilisable sur planche ou armoire

KOD CODE	MODEL DESCRIPTION	EBATLAR DIMENSIONS	KG KG	GÜÇ POWER	DG SARFIYAT N.GAS EXPENDITURE	BASINÇ PRESSURE	FİYAT PRICE
GAST-9LIG40	40 lık Lavataş Izgara Lavastone Grill	400 x 930 x 850	85 Kg.	8 kW	0,84 m ³	20 mbar	1.320 €
GAST-9LIG80	80 lık Lavataş Izgara Lavastone Grill	800 x 930 x 850	160 Kg.	16 kW	1,69 m ³	20 mbar	1.825 €

DÖKÜM IZGARA / CAST IRON GRILL / GRILL EN FONTE



- TR**
- Paslanmaz çelik gövde
 - Emniyet ventilli valf
 - Alev denetleme tertibatı
 - Piezoelektrik ateşlemeli, pilotlu
 - Su çekmecesi
 - Döküm pişirme yüzeyi
 - LPG ve Doğalgaza uyumlu
 - Yağ toplama kanalı, boşaltma çekmecesi
 - Ayarlanabilir ayaklar
 - Kolay temizlenebilir
 - Uzun ömürlü

- EN**
- Stainless steel body
 - Safety gas valve with thermocouple
 - Fire inspect system
 - Piezoelectric ignition, pilot flame
 - Available LPG and Natural Gas
 - Water drawer
 - Cast iron surface
 - Fat collecting drawer
 - Adjustable legs
 - Easy to clean
 - Long life



GAST-9DIG80

- FR**
- Cabinet vapeur rend la cuisson plus facile.
 - Adaptable à fonctionner au GPL et GN.
 - Soupape de sécurité magnétique.
 - Chauffage bi-zone sur le module complet
 - Contrôle par l'allumage Piezo pour chaque brûleurs.
 - Plaque en fonte.
 - Nettoyage facile grâce à la conception hygiénique.
 - Corps en acier inoxydable.

KOD CODE	MODEL DESCRIPTION	EBATLAR DIMENSIONS	KG KG	GÜÇ POWER	DG SARFIYAT N.GAS EXPENDITURE	BASINÇ PRESSURE	FİYAT PRICE
GAST-9DIG40	40 lık Döküm Izgara Cast Iron Grill	400 x 930 x 850	70 Kg.	8 kW	0,84 m ³	20 mbar	1.525 €
GAST-9DIG80	80 lık Döküm Izgara Cast Iron Grill	800 x 930 x 850	135 Kg.	16 kW	1,69 m ³	20 mbar	2.170 €

PATATES DİNLENDİRME / HEATED CHIPS UNIT / REPOSE POMME DE TERRE



- TR**
- Paslanmaz çelik gövde
 - Ayarlanabilir ayaklar
 - Kolay temizlenebilir
 - Uzun ömürlü

- EN**
- Stainless steel body
 - Adjustable legs
 - Easy to clean
 - Long life

- FR**
- Permet de garder les frites au chaud et d'égouter l'huile.
 - Capacité du bac; GN 1/1 x 150 mm.
 - La forme spéciale sur le conteneur, permet une efficacité maximale pour vidanger l'huile.
 - Nettoyage facile grâce à la conception hygiénique.
 - Corps en acier inoxydable.

**GAST-9PDE40**

KOD CODE	MODEL DESCRIPTION	EBATLAR DIMENSIONS	KG KG	GÜÇ POWER	ENERJİ ENERGY	FİYAT PRICE
GAST-9PDE40	Patates Dinlendirme Heated Chips Unit	400 x 930 x 850	47 Kg.	1,5 kW	230 V ~ 50 Hz	940 €

MAKARNA HAŞLAMA / PASTA COOKER / CUISSEUR A PÂTE



- TR**
- Paslanmaz çelik gövde
 - Kolay temizlenebilir
 - Hijyenik
 - Tahliye vanası
 - Yekpare bankolu havuz
 - 30-120°C ayarlı termostat
 - 24 lt kaynatma kapasitesi
 - Ayarlanabilir ayaklar
 - Uzun ömürlü

- EN**
- Stainless steel body
 - Easy to clean
 - Hygienic
 - With drainage pipe
 - Monoblock bowl
 - 30-120°C Adjustable thermostat
 - 24 Liter boiling capacity
 - Adjustable legs
 - Long life

- FR**
- Commande thermostatique.
 - Panier en acier inoxydable.
 - Robinet de remplissage d'eau.
 - Robinet de vidange.
 - Système de drainage de l'eau débordant.
 - Nettoyage facile grâce à la conception hygiénique.
 - Corps en acier inoxydable.



GAST-9MH40

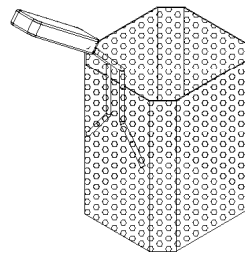

KOD CODE	EBATLAR DIMENSIONS	FİYAT PRICE
GAST-9MKN.SPT.07	136 x 148 x 194	60 €

KOD CODE	MODEL DESCRIPTION	EBATLAR DIMENSIONS	LİTRE LITER	KG KG	GÜÇ POWER	ENERJİ ENERGY	FİYAT PRICE
GAST-9MH40	Makarına Haşlama Pasta Cooker	400 x 930 x 850	24 Lt.	48 Kg.	10 kW	400 V 3 ~ 60 Hz	1.700 €

40 LİK BENMARİ / BAIN-MARIE / BAIN-MARIE



- TR**
- Paslanmaz çelik gövde
 - Gastronom küvetlere uygun hazne
 - Kolay temizlenebilir
 - Hijyenik
 - Tahliye vanası
 - Yekpare havuz
 - 30-120°C ayarlı termostat
 - Ayarlanabilir ayaklar
 - Uzun ömürlü



GAST-9BM40

80 LİK BENMARİ / BAIN-MARIE / BAIN-MARIE



- EN**
- Stainless steel body
 - Reservoir available for gastronom cups
 - Easy to clean
 - Hygienic
 - Drainage pipe
 - Nonoblock bowl
 - 30-120°C Adjustable thermostat
 - Adjustable legs
 - Long life



GAST-9BM80

- FR**
- Commande thermostatique.
 - Capacité de module-demi; 1 GN 1/1.
 - Capacité de module-complet; 2 x GN 1/1.
 - Robinet de remplissage d'eau.
 - Nettoyage facile grâce à la conception hygiénique.
 - Corps en acier inoxydable.

KOD CODE	MODEL DESCRIPTION	EBATLAR DIMENSIONS	KG KG	GÜÇ POWER	ENERJİ ENERGY	FİYAT PRICE
GAST-9BM40	40 lık Benmari Bain-Marie	400 x 930 x 850	35 Kg.	1,5 kW	230 V ~ 50 Hz	1.070 €
GAST-9BM80	80 lık Benmari Bain-Marie	800 x 930 x 850	57 Kg.	3 kW	230 V ~ 50 Hz	1.500 €

40 LİK NÖTR TEZGAH / NOTR BENCH / COMPTOIR NEUTRE



- TR**
- Paslanmaz çelik gövde
 - Ayarlanabilir ayaklar
 - Kolay temizlenebilir
 - Uzun ömürlü

- EN**
- Stainless steel body
 - Adjustable legs
 - Easy to clean
 - Long life



GAST-9NT40

80 LİK NÖTR TEZGAH / NOTR BENCH / COMPTOIR NEUTRE



- FR**
- Idéal pour la préparation.
 - Nettoyage facile grâce à la conception hygiénique.
 - Corps en acier inoxydable.



GAST-9NT80

KOD CODE	MODEL DESCRIPTION	EBATLAR DIMENSIONS	KG KG	FİYAT PRICE
GAST-9NT40	40 lık Nötr Tezgah Notr Bench	400 x 930 x 850	30 Kg.	615 €
GAST-9NT80	80 lık Nötr Tezgah Notr Bench	800 x 930 x 850	45 Kg.	850 €

KAYNATMA TENCERELERİ (ENDİREKT ISITMA) / BOILING PANS (INDIRECT HEATING) / MARMITES (INDIRECT)



- TR**
- Paslanmaz çelik gövde
 - Karşı ağırlıklı katlanır kapak
 - Komple mıknatıslı güvenlik valfli brülör
 - Ateşleme ve durdurma düğmesini birlikte içeren pilot termokuplu.
 - Soğuk ve sıcak su doldurma musluğu
 - Drenaj musluğu



GAST-9KT80

- EN**
- Stainless steel body
 - Counterweighted folding lid
 - Burner with complete magnet security valve
 - Which contains ignition and stop button together with pilot thermocouple
 - Cold and hot water filling cock
 - Drainage cock



- FR**
- Contrôle de la valve sous-présion avec le manomètre.
 - Robinet de remplissage d'eau chaude et froide.
 - Robinet de drainage.
 - Clapet de surcharge.
 - Bac avec double casseroles.
 - Nettoyage facile grâce à la conception hygiénique.
 - Corps en acier inoxydable.

KOD CODE	MODEL DESCRIPTION	EBATLAR DIMENSIONS	LİTRE LITER	KG KG	GÜÇ POWER	ENERJİ ENERGY	FİYAT PRICE
GAST-9KT80	Elektrikli Kaynatma Tenceresi Electric Boiling Pan	800 x 930 x 850	100 Lt.	134 Kg.	18 kW	400 V 3 ~ 60 Hz	5.595 €
GAST-9KT800	Elektrikli Kaynatma Tenceresi Electric Boiling Pan	800 x 930 x 850	150 Lt.	175 Kg.	20 kW	400 V 3 ~ 60 Hz	5.785 €
GAST-9KT90	Elektrikli Kaynatma Tenceresi Electric Boiling Pan	900 x 1000 x 950	250 Lt.	185 Kg.	30 kW	400 V 3 ~ 60 Hz	7.040 €

KOD CODE	MODEL DESCRIPTION	EBATLAR DIMENSIONS	LİTRE LITER	KG KG	GÜÇ POWER	DG SARFIYAT N.GAS EXPENDITURE	BASINÇ PRESSURE	FİYAT PRICE
GAST-9KTG80	Gazlı Kaynatma Tenceresi Gas Boiling Pan	800 x 930 x 850	100 Lt.	130 Kg.	21,3 kW	2,25 m ³	20 mbar	5.595 €
GAST-9KTG800	Gazlı Kaynatma Tenceresi Gas Boiling Pan	800 x 930 x 850	150 Lt.	155 Kg.	21,3 kW	2,25 m ³	20 mbar	5.785 €
GAST-9KTG90	Gazlı Kaynatma Tenceresi Gas Boiling Pan	900 x 1000 x 950	250 Lt.	195 Kg.	42,6 kW	4,5 m ³	20 mbar	7.040 €

DEVİRİLİR TAVA / TILTING BRATT PAN / SAUTEUSES BASCULANTE



- TR**
- Gövde, panel, tava paslanmaz çelik
 - Kaldırma mekanizması el ile çalışır
 - Paslanmaz çelik brülör ateşlemeli, pilotlu termokuplu ve termostatlı
 - Alev sönerse gaz kesilir
 - LPG ve Doğalgaza uyumludur
 - Cihaz üstündeki musluk ile doldurma ve yıkama yapmak kolaydır



GAST-9DT80

- EN**
- Body, panelling and pan made of stainless steel
 - The tilting mechanism is manual operated
 - Stainless steel burner with ignition, pilot thermocouple and thermostat
 - If the flame goes out, gas are cutted off
 - Operable with LPG and Natural Gas
 - Filling with faucet on top of device and washing is easy



GAST-9DTG120

- FR**
- Système de levage manuel.
 - Clapet de surcharge.
 - Interrupteur de sécurité.
 - Nettoyage facile grâce à la conception hygiénique.
 - Construction en acier inoxydable.

KOD CODE	MODEL DESCRIPTION	EBATLAR DIMENSIONS	LİTRE LITER	KG KG	GÜÇ POWER	ENERJİ ENERGY	FİYAT PRICE
GAST-9DT80	Elektrikli Devrilir Tava Electric Tilting Bratt Pan	800 x 930 x 850	80 Lt.	160 Kg.	12 kW	400V 3 ~ 60 Hz	4.275 €
GAST-9DT120	Elektrikli Devrilir Tava Electric Tilting Bratt Pan	1200 x 930 x 850	120 Lt.	220 Kg.	18 kW	400V 3 ~ 60 Hz	5.635 €

KOD CODE	MODEL DESCRIPTION	EBATLAR DIMENSIONS	LİTRE LITER	KG KG	GÜÇ POWER	DG SARFIYAT N.GAS EXPENDITURE	BASINÇ PRESSURE	FİYAT PRICE
GAST-9DTG80	Gazlı Devrilir Tava Gas Tilting Bratt Pan	800 x 930 x 850	80 Lt.	122 Kg.	19 kW	2,01 m ³	20 mbar	4.215 €
GAST-9DTG120	Gazlı Devrilir Tava Gas Tilting Bratt Pan	1200 x 930 x 850	120 Lt.	230 Kg.	22 kW	2,32 m ³	20 mbar	5.635 €

4 LÜ ELEKTRİKLİ KUZİNE / ELECTRIC RANGE WITH 4 HOT PLATES / CUISINIÈRE ELECTRIQUE

- TR**
- Paslanmaz çelik gövde
 - Pik dökümü 30x30 cm 4 kW pleytler
 - 6 kademeli kontrol edilebilir
 - Fırın ölçüleri GN 2/1 göre
 - Fırın sıcaklığı 50-300°C arası ayarlanabilir
 - Fırın içi rezistanslar alt ve üst olarak ayrı ayrı kontrol edilebilir
 - İzolasyonlu fırın
 - Seyyar GN 2/1 tel raf
 - Ayarlanabilir ayaklar



GAST-9KZ80

6 LI ELEKTRİKLİ KUZİNE / ELECTRIC RANGE WITH 6 HOT PLATES / CUISINIÈRE ELECTRIQUE

- EN**
- Stainless steel body
 - 30x30 cm 4 kW heaters
 - Adjustable control system
 - Oven size is GN 2/1
 - Oven thermostat adjustment between 50°C to 300°C
 - Oven heaters work separately or together
 - Isolated oven
 - Removable wire tray size GN 2/1
 - Adjustable legs

- FR**
- Boîtier en acier inoxydable
 - Dimensions fontes 30x30cm plaques 4kw
 - Contrôlable à 6 niveaux
 - Dimensions du four selon GN 2/1
 - Température du four réglable 50°C-300°C
 - Température résistance, réglable séparément pour cuisson supérieure et inférieure
 - isolation thermique
 - Grilles mobiles GN 2/1
 - Pieds réglable



GAST-9KZ120

KOD CODE	MODEL DESCRIPTION	EBATLAR DIMENSIONS	KG KG	GÜÇ POWER	ENERJİ ENERGY	FİYAT PRICE
GAST-9KZ80	4 lü Elektrikli Kuzine Electric Range With 4 Hot Plates	800 x 930 x 850	222 Kg.	21 kW	400 V 3 ~ 60 Hz	3.460 €
GAST-9KZ120	6 lü Elektrikli Kuzine Electric Range With 6 Hot Plates	1200 x 930 x 850	265 Kg.	29 kW	400 V 3 ~ 60 Hz	4.465 €

4 LÜ GAZLI KUZİNE / GAS RANGE WITH 4 BURNERS / CUISINIÈRE A GAZ



- TR**
- Paslanmaz çelik gövde
 - Emniyet ventilli valf
 - Alev denetleme tertibatı
 - Sanayi tipi döküm
 - LPG ve Doğalgaza uyumlu
 - Piezoelektrik ateşlemeli, pilotlu
 - Fırın ölçüleri GN 2/1 göre
 - Fırın sıcaklığı 50-300°C arası ayarlanabilir
 - İzolasyonlu fırın
 - Seyyar GN 2/1 tel raf
 - Kolay temizlenebilir
 - Ayarlanabilir ayaklar



GAST-9KZG80

6 LI GAZLI KUZİNE / GAS RANGE WITH 6 BURNERS / CUISINIÈRE A GAZ



- EN**
- Stainless steel body
 - Safety gas valve with thermocouple
 - Fire inspect system
 - Heavy duty top cast iron
 - Available LPG and Natural Gas
 - Piezoelectric ignition and pilot flame
 - Adjustable control system
 - Oven size GN 2/1
 - Oven thermostat adjustable from 50°C to 300°C
 - Isolated oven
 - Removable wire tray size GN 2/1
 - Easy to clean
 - Adjustable legs



GAST-9KZG120

- FR**
- Adaptable à fonctionner au GPL et GN.
 - Construction interne complètement en acier inoxydable avec des plateaux 2xGN 2/1.
 - Vanne de gaz thermostatique réglable.
 - Soupape de sécurité magnétique.
 - La fonte supérieur permet une excellente résistance aux chocs.
 - Contrôle par l'allumage Piezo pour chaque brûleurs.
 - Nettoyage facile grâce à la conception hygiénique.
 - Corps en acier inoxydable.

KOD CODE	MODEL DESCRIPTION	EBATLAR DIMENSIONS	KG KG	GÜÇ POWER	DG SARFIYAT N.GAS EXPENDITURE	BASINÇ PRESSURE	FİYAT PRICE
GAST-9KZG80	4 lü Gazlı Kuzine Gas Range With 4 Burners	800 x 930 x 850	223 Kg.	42 kW	4,44 m ³	20 mbar	2.680 €
GAST-9KZG120	6 lü Gazlı Kuzine Gas Range With 6 Burners	1200 x 930 x 850	266 Kg.	58 kW	6,13 m ³	20 mbar	3.600 €

KAPALI ATEŞ ELEKTRİKLİ KUZİNE / ELECTRIC SOLID TOP / CUISINIÈRE ELECTRIQUE A FONTE



TR

- Paslanmaz çelik gövde
- Pişirme yüzeyi 15mm ST52 Pleyt
- 4 bölge kontrol edilebilen pişirme yüzeyi
- Fırın ölçüleri GN 1/1 göre
- Fırın sıcaklığı 50°C-300°C arası ayarlanabilir
- Fırın içi rezistanslar alt ve üst olarak ayrı ayrı kontrol edilir
- İzolasyonlu fırın
- Seyyar GN 1/1 tel raf
- Ayarlanabilir ayaklar

EN

- Stainless steel body
- Type of cooking plate 15mm ST52
- Cooking surface able to control by 4 independent zones
- Oven size is GN 1/1
- Oven thermostat adjustment between 50°C to 300°C
- Oven heaters work separately or together
- Isolated oven
- Removable wire tray size GN 1/1
- Adjustable legs

FR

- Boîtier en acier inoxydable
- Surface de cuisson plate 15mm ST52
- Surface de cuisson contrôlable à 4 zones indépendants
- Mesures du four d'après GN 1/1
- Température du four réglable (50°C-300°C)
- Résistance du four contrôlable pour cuisson séparable haut et bas
- Four isolé
- Grille mobile GN 1/1
- Pieds réglable



GAST-9KKZ80

KOD CODE	MODEL DESCRIPTION	EBATLAR DIMENSIONS	KG KG	GÜÇ POWER	ENERJİ ENERGY	FİYAT PRICE
GAST-9KKZ80	Kapalı Ateş Elektrikli Kuzine Solid Top Electric With Oven	800 x 930 x 850	222 Kg.	17 kW	400 V 3 ~ 60 Hz	3.210 €
GAST-9KKZ800	Kapalı Ateş Elektrikli Ocak Solid Top Electric	800 x 930 x 850	222 Kg.	12 kW	400 V 3 ~ 60 Hz	2.515 €

KAPALI ATEŞ GAZLI KUZİNE / SOLID TOP GAS WITH OVEN / CUISINIÈRE GAZ A FONTE

TR

- Paslanmaz çelik gövde
- 3 parçalı sanayi tip döküm yüzey
- Emniyet ventilli valf
- Alev denetleme tertibatı
- Sanayi tipi döküm
- LPG ve Doğalgaza uyumlu
- Kolay temizlenebilir pislik tepsi
- Piezoelektrik ateşlemeli, pilotlu
- Termostat kontrollü fırın 100-300°C arası ayarlanabilir
- Fırın ölçüleri GN 2/1 göre
- İzolasyonlu fırın
- Seyyar GN 2/1 tel raf
- Ayarlanabilir ayaklar

EN

- Stainless steel body
- 3 pieces heavy duty cast iron
- Safety gas valve with thermocouple
- Fire inspect system
- Heavy duty top cast iron
- Available LPG or Natural Gas
- Easy to clean
- Piezoelectric ignition and pilot flame
- Oven thermostat adjustment between 100°C to 300°C
- Oven size is GN 2/1
- Isolated oven
- Removable wire tray size GN 2/1
- Adjustable legs

FR

- Boîtier en acier inoxydable
- 3 pièces en fonte robuste
- Thermo couple
- Dispositif du contrôle de feu
- Fonte de type industriel
- Compatible au GPL- Gaz Naturel
- Nettoyage facile de la saleté du plateau
- Pilote d'allumage piézo-électrique
- Thermostat contrôle cuisson (100°C-300°C)
- Dimension du four selon GN 2/1
- Four isolé
- Grille mobile GN 2/1
- Pieds réglable



GAST-9KKZG80

KOD CODE	MODEL DESCRIPTION	EBATLAR DIMENSIONS	KG KG	GÜÇ POWER	DG SARFIYAT N.GAS EXPENDITURE	BASINÇ PRESSURE	FİYAT PRICE
GAST-9KKZG80	Kapalı Ateş Gazlı Kuzine Solid Top Gas With Oven	800 x 930 x 850	130 Kg.	12,5 kW	1,30 m ³	20 mbar	3.020 €
GAST-9KKZG800	Kapalı Ateş Gazlı Ocak Solid Top Gas	800 x 930 x 850	130 Kg.	7,5 kW	0,78 m ³	20 mbar	2.200 €



KAFETERYA
CAFETERIA
Cafeterias

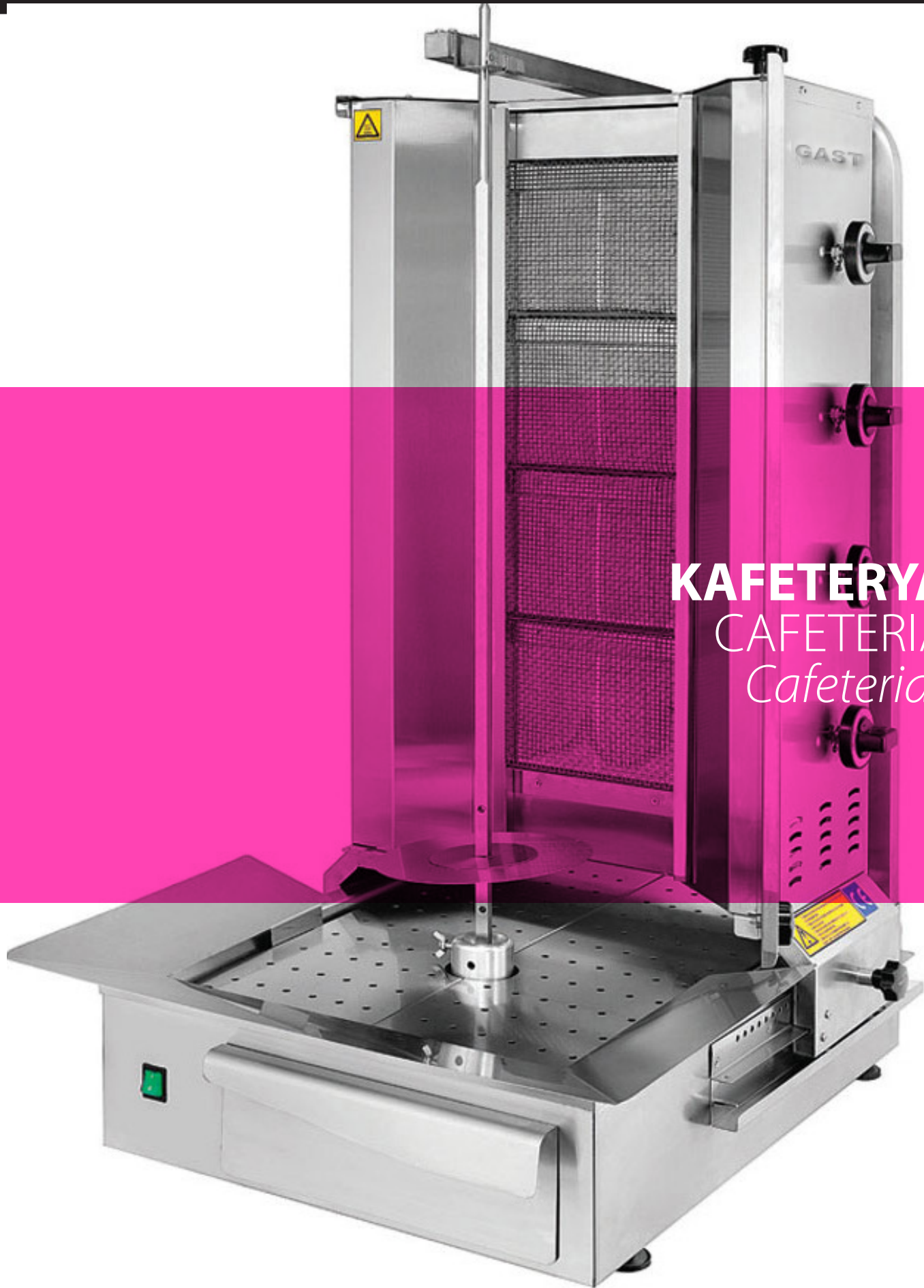

3 LÜ MOTORLU DÖNER OCAĞI / DONER MACHINE WITH 3 BURNERS (LOWER DRIVE)
/ MACHINE A KEBAB A 3 RADIANTS



TR

- Paslanmaz çelik gövde
- LPG ve Doğalgaza uyumlu
- Emniyet ventilli valf
- Alev denetleme tertibatı
- Alev paneli
- Kolay temizlenebilir
- Radyanlar max-min olarak bağımsız çalışır
- Alttan motorlu, elektrikli
- Yağ toplama tepsisi, boşaltma çekmecesini
- Gövdenin hareketi ile döner ve radyan arası ayarlanabilir

EN

- Stainless steel body
- Available LPG and Natural Gas
- Safety gas valve with thermocouple
- Fire inspect system
- Fire panel
- Easy to clean
- The heating elements able to work separately
- Electrical lower drive
- With removable fat collecting drawer
- Moving body



GAST-MD03

4 LÜ MOTORLU DÖNER OCAĞI / DONER MACHINE WITH 4 BURNERS (LOWER DRIVE)
/ MACHINE A KEBAB A 4 RADIANTS



FR

- Boitier en acier inoxydable
- Compatible au GPL et Gaz Natural
- Thermo couple
- Dispositif de surveillance de flamme
- Panneau de flamme
- Nettoyage facile
- Fonctionnement indépendant des radiants au max-minimum
- Moteur électrique est en bas
- Canal de collecte de graisse-Trioir dégager
- Réglage du pivotement du doner et radiant



GAST-MD04

KOD CODE	MODEL DESCRIPTION	EBATLAR DIMENSIONS	KG KG	GÜÇ POWER	DG SARFIYAT N.GAS EXPENDITURE	BASINÇ PRESSURE	FİYAT PRICE
GAST-MD03	3 lü Motorlu Döner Ocağı Doner Machine With 3 Burners (Lower Drive)	540 x 660 x 900	28 Kg.	9,75 kW	1,00 m ³	20 mbar	1.105 €
GAST-MD04	4 lü Motorlu Döner Ocağı Doner Machine With 4 Burners (Lower Drive)	540 x 660 x 1100	30 Kg.	13 kW	1,33 m ³	20 mbar	1.205 €

3 LÜ DÖNER OCAĞI / DONER GRILL MACHINE
/ MACHINE A KEBAB A 3 RADIANTS



TR

- Paslanmaz çelik gövde
- LPG ve Doğalgaza uyumlu
- Emniyet ventilli valf
- Alev denetleme tertibatı
- Alev paneli
- Kolay temizlenebilir
- Radyanlar max-min olarak bağımsız çalışır

EN

- Stainless steel body
- Available LPG and Natural Gas
- Safety gas valve with thermocouple
- Fire inspect system
- Fire panel
- Easy to clean
- The heating elements able to work separately



GAST-DO3

4 LÜ DÖNER OCAĞI / DONER GRILL MACHINE
/ MACHINE A KEBAB A 4 RADIANTS



FR

- Boitier en acier inoxydable
- Compatible au GPL en GAZ naturel
- Thermo couple
- Dispositif de surveillance de flamme
- Panneau de flamme
- Fonctionnement indépendant des radiants



GAST-DO4

KOD CODE	MODEL DESCRIPTION	EBATLAR DIMENSIONS	KG KG	GÜÇ POWER	DG SARFIYAT N.GAS EXPENDITURE	BASINÇ PRESSURE	FİYAT PRICE
GAST-DO3	3 lü Döner Ocağı Doner Machine With 3 Burners	500 x 550 x 750	23 Kg.	9,75 kW	1,00 m ³	20 mbar	700 €
GAST-DO4	4 lü Döner Ocağı Doner Machine With 4 Burners	500 x 550 x 950	24 Kg.	13 kW	1,33 m ³	20 mbar	815 €

LÜKS SOSİSLİK / HOT-DOG COOKER / CUISSEUR DES SAUCISSES



TR

- Paslanmaz çelik gövde
- Kolay temizlenebilir
- Spot aydınlatmalı
- GN-2/3 göre

EN

- Stainless steel body
- Easy to clean
- Long life
- Spotlight
- GN-2/3

FR

- Boîtier en acier inoxydable
- Nettoyage facile
- Éclairage en spot
- Système GN-2/3



GAST-LKS500



KOD CODE	MODEL DESCRIPTION	EBATLAR DIMENSIONS	KG KG	GÜÇ POWER	ENERJİ ENERGY	FİYAT PRICE
GAST-LKS500	Lüks Sosislik Hot-Dog Cooker	500 x 300 x 250	15 Kg.	2,5 kW	230 V ~ 50 Hz	330 €

40 LİK ISLAK HAMBURGER / SAUCE HAMBURGER MACHINE
/ MACHINE POUR HAMBURGER HUMIDE



TR

- Paslanmaz çelik gövde
- Çift buhar hazneli
- Spot aydınlatmalı
- Hijyenik
- Tahliye vanası
- 30°-120°C termostat kontrollü
- Su sızdırmazlık, izolasyonlu
- Yekpare havuz
- Kolay temizlenebilir
- Ayarlanabilir ayaklar

EN

- Stainless steel body
- Double steam boiler
- Spotlight
- Hygienic
- With water drainage
- Thermostat adjustment from 30°C to 120°C
- Isolated
- One piece pool
- Easy to clean
- Adjustable legs



GAST-IHB40

60 LİK ISLAK HAMBURGER / SAUCE HAMBURGER MACHINE
/ MACHINE POUR HAMBURGER HUMIDE



FR

- Boîtier en acier inoxydable
- Réservoir à double vapeur
- Éclairage en spot
- Hygiénique
- Soupape d'évacuation
- Thermostat contrôle (30°C-120°C)
- Isolation contre fuites d'eau
- Bac monobloc
- Nettoyage facile
- Pieds réglable



GAST-IHB60

KOD CODE	MODEL DESCRIPTION	EBATLAR DIMENSIONS	KG KG	GÜÇ POWER	ENERJİ ENERGY	FİYAT PRICE
GAST-IHB40	40 lık Islak Hamburger Souce Hamburger Machine	400 x 600 x 250	26 Kg.	2,5 kW	230 V ~ 50 Hz	775 €
GAST-IHB60	60 lık Islak Hamburger Souce Hamburger Machine	600 x 600 x 250	30 Kg.	2,5 kW	230 V ~ 50 Hz	895 €

45 LİK HAREKETLİ SALAMANDER / LIFT SALAMENDER / SALAMANDRE



TR

- Paslanmaz çelik gövde
- Kolay temizlenebilir
- 2 kademeli kontrol edilebilir

EN

- Stainless steel body
- Easy to clean
- Adjustable thermostat



GAST-HSE45

65 LİK HAREKETLİ SALAMANDER / LIFT SALAMENDER / SALAMANDRE



FR

- Boîtier en acier inoxydable
- Nettoyage facile
- Contrôle à 2 niveaux



GAST-HSE65

KOD CODE	MODEL DESCRIPTION	EBATLAR DIMENSIONS	KG KG	GÜÇ POWER	ENERJİ ENERGY	FİYAT PRICE
GAST-HSE45	45 lik Hareketli Salamander Lift Salamander	450 x 500 x 600	32 Kg.	3,5 kW	230 V ~ 50 Hz	830 €
GAST-HSE65	65 lik Hareketli Salamander Lift Salamander	650 x 500 x 600	45 Kg.	3,5 kW	230 V ~ 50 Hz	965 €

BENMARİ / BAIN-MARIE / BAIN MARIE



TR

- Paslanmaz çelik gövde
- Kolay temizlenebilir
- Taban raflı, etrafı kapalı
- 30°-120° termostat kontrolü
- Tahliye vanası

EN

- Stainless steel body
- With cupboard
- Easy to clean
- 30°-120° adjustable thermostat
- Drainage pipe



GAST-BM400

AHŞAP KAPLAMALI BENMARİ / WOOD COATING BAIN-MARIE
/ BAIN- MARIE HABILLAGE PLAQUE EN BOIS



FR

- Boitier en acier inoxydable
- Nettoyage facile
- Base à étagères contour fermé
- Thermostat contrôle (30°C-120°C)
- Soupape d'évacuation



KOD CODE	MODEL DESCRIPTION	EBATLAR DIMENSIONS	KG KG	GÜÇ POWER	ENERJİ ENERGY	FİYAT PRICE
GAST-BM300	3 Sıcak Benmari Elk Bain-Marie	1200 x 700 x 850	121 Kg.	2,5 kW	230 V ~ 50 Hz	1.260 €
GAST-BM310N	3 Sıcak 1 Nötr Benmari Elk Bain-Marie	1500 x 700 x 850	145 Kg.	2,5 kW	230 V ~ 50 Hz	1.510 €
GAST-BM400	4 Sıcak Benmari Elk Bain-Marie	1500 x 700 x 850	145 Kg.	2,5 kW	230 V ~ 50 Hz	1.525 €
GAST-BM410N	4 Sıcak 1 Nötr Benmari Elk Bain-Marie	1800 x 700 x 850	169 Kg.	2,5 kW	230 V ~ 50 Hz	1.800 €
GAST-BM500	5 Sıcak Benmari Elk Bain-Marie	1800 x 700 x 850	169 Kg.	5 kW	230 V ~ 50 Hz	1.925 €
GAST-BM600	6 Sıcak Benmari Elk Bain-Marie	2100 x 700 x 850	200 Kg.	5 kW	230 V ~ 50 Hz	2.390 €

TR

- Paslanmaz çelik gövde
- Kolay temizlik
- Isı yalıtımlı
- 5 tepsi (80x60'e göre) kapasiteli
- LPG ve Doğalgaz uyumlu
- Isıya dayanıklı çift camlı kapı
- Piezoelektrik ateşlemeli, pilotlu
- Emniyet sistemli musluk
- Paslanmaz atmosferik brülörler
- Ürün alt grup ve üst grup olarak iki parçadan oluşur.



GAST-PBRK90

EN

- Stainless steel body
- Easy to clean
- 5 trays capacity
- Available Natural Gas and LPG
- Resistant to heating double glass
- Piezoelectricity firing and pilot system
- Safety system
- Stainless steel atmospheric burners system
- Created by independence two pieces

FR

- Boîtier en acier inoxydable
- Nettoyage facile
- Isolation thermique
- Capacité de cuisson à 5 plateaux (selon GN 2/1)
- Double portes vitrées résistantes à la chaleur
- Pilote d'allumage piézo-électrique
- Robinet avec système sécurité
- Brûleurs atmosphériques inoxydables
- Four avec support



GAST-PBRK75

KOD CODE	MODEL DESCRIPTION	EBATLAR DIMENSIONS	KG KG	GÜÇ POWER	DG SARFIYAT N.GAS EXPENDITURE	BASINÇ PRESSURE	FİYAT PRICE
GAST-PBRK90	Pasta Börek Bakery Oven	900 x 900 x 1700	188 Kg.	30 kW	3,12 m ³	20 mbar	2.280 €
GAST-PBRK75	Mayalama Dolabı Yeast Cupboard	750 x 800 x 450	47 Kg.	1250 W	-	-	960 €

KUZİNELER

RANGES

Cuisinières



ELEKTRİKLİ KUZİNELER / ELECTRIC RANGES / CUISINIÈRE ELECTRIQUE



- TR**
- Paslanmaz çelik gövde
 - Pik dökümlü 30x30 cm 4 kW pleytler
 - 6 kademeli kontrol edilebilir
 - Fırın ölçüleri GN 2/1 göre
 - Fırın sıcaklığı 50-300°C arası ayarlanabilir
 - Fırın içi rezistanslar alt ve üst olarak ayrı ayrı kontrol edilir
 - İzolasyonlu fırın
 - Seyyar GN 2/1 tel raf
 - Ayarlanabilir ayaklar

- EN**
- Stainless steel body
 - 30x30 cm 4 kW plate
 - Adjustable control system
 - Oven size is GN 2/1
 - Oven thermostat adjustment from 50°C to 300°C
 - For oven resistances work separately or together
 - Isolated oven
 - Removable wire tray size GN 2/1
 - Adjustable legs

- FR**
- Boîtier en acier inoxydable
 - Dimensions fontes 30x30 cm plaques 4 kW
 - Contrôlable à 6 niveaux
 - Dimensions du four selon GN 2/1
 - Température du four réglable 50°C-300°C
 - Température résistance, réglable séparément pour cuisson supérieure et inférieure
 - Isolation thermique
 - Grilles mobiles GN 2/1
 - Pieds réglable



GAST-KZE4100

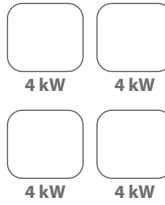

KOD CODE	MODEL DESCRIPTION	EBATLAR DIMENSIONS	KG KG	GÜÇ POWER	ENERJİ ENERGY	FİYAT PRICE
GAST-KZE2100	2 li Elektrikli Kuzine Electric Range	1000 x 700 x 850	110 Kg.	13 kW	400 V 3 ~ 60 Hz	2.390 €
GAST-DOA2100	2 li Dolaplı Ocak (Tab.Raf.Etr. Açık) Electric Cooker With Open Stand	1000 x 700 x 850	90 Kg.	8 kW	400 V 3 ~ 60 Hz	1.575 €
GAST-DO2100	2 li Dolaplı Ocak (Kapisız) Electric Cooker With Cupboard	1000 x 700 x 850	90 Kg.	8 kW	400 V 3 ~ 60 Hz	1.635 €
GAST-KZE4100	4 lü Elektrikli Kuzine Electric Range	1000 x 1000 x 850	155 Kg.	21 kW	400 V 3 ~ 60 Hz	3.460 €
GAST-DOA4100	4 lü Dolaplı Ocak (Tab.Raf.Etr. Açık) Electric Cooker With Open Stand	1000 x 1000 x 850	135 Kg.	16 kW	400 V 3 ~ 60 Hz	2.705 €
GAST-DO4100	4 lü Dolaplı Ocak (Kapisız) Electric Cooker With Cupboard	1000 x 1000 x 850	135 Kg.	16 kW	400 V 3 ~ 60 Hz	2.770 €
GAST-KZE6100	6 lü Elektrikli Kuzine Electric Range	1500 x 1000 x 850	175 Kg.	29 kW	400 V 3 ~ 60 Hz	4.400 €
GAST-DOA6150	6 lü Dolaplı Ocak (Tab.Raf.Etr. Açık) Electric Cooker With Open Stand	1500 x 1000 x 850	150 Kg.	24 kW	400 V 3 ~ 60 Hz	3.245 €
GAST-DO6150	6 lü Dolaplı Ocak (Kapisız) Electric Cooker With Cupboard	1500 x 1000 x 850	150 Kg.	24 kW	400 V 3 ~ 60 Hz	3.310 €

TR

- Paslanmaz çelik gövde
- Emniyet ventilli valf
- Alev denetleme tertibatı
- 40x50 Sanayi tipi döküm
- LPG ve Doğalgaza uyumlu
- Kolay temizlenebilir pislik tepsi
- Piezoelektrik ateşlemeli, pilotlu
- Fırın ölçüleri GN 2/1 göre
- Termostat kontrollü fırın 100-300°C arası ayarlanabilir
- İzolasyonlu fırın
- Seyyar GN 2/1 tel raf
- Ayarlanabilir ayaklar



GAST-KUZG4100

EN

- Stainless steel body
- Safety gas valve with thermocouple
- Fire inspect system
- Heavy duty top cast iron
- Available LPG or Natural Gas
- Easy to clean
- Piezoelectric ignition and pilot flame
- Oven size is GN 2/1
- Oven thermostat adjustment from 100°C to 300°C
- Isolated oven
- Removable wire tray size GN 2/1
- Adjustable legs



FR

- Boitier en acier inoxydable
- Thermocouple
- Dispositif de surveillance de flamme
- Fonte type industriel
- Compatible au GPL et Gaz Natural
- Nettoyage facile des plateaux
- Pilote d'allumage piézo-électrique
- Thermostat contrôle cuisson à 100°C-300°C
- Dimension du four selon GN 2/1
- Isolation thermique
- Grilles mobiles GN 2/1
- Pieds réglable



GAST-KUZG6150

KOD CODE	MODEL DESCRIPTION	EBATLAR DIMENSIONS	KG KG	GÜÇ POWER	DG SARFIYAT N.GAS EXPENDITURE	BASINÇ PRESSURE	FİYAT PRICE
GAST-KUZG2100	2 li Gazlı Kuzine Gas Range With 2 Burners	1000 x 700 x 850	110 Kg.	21 kW	1,65 m ³	20 mbar	1.920 €
GAST-KUZG4100	4 lü Gazlı Kuzine Gas Range With 4 Burners	1000 x 1000 x 850	182 Kg.	35 kW	3,64 m ³	20 mbar	2.580 €
GAST-KUZG6150	6 lü Gazlı Kuzine Gas Range With 6 Burners	1500 x 1000 x 850	190 Kg.	49 kW	5,10 m ³	20 mbar	3.245 €

- TR**
- Paslanmaz çelik gövde
 - Emniyet ventilli valf
 - Alev denetleme tertibatı
 - Pilot yanış sistemi
 - Sanayi tipi döküm
 - LPG ve Doğalgaza uyumlu
 - Ayarlanabilir ayaklar
 - Kolay temizlenebilir
 - Uzun ömürlü

- EN**
- Stainless steel body
 - Safety gas valve with thermocouple
 - Fire inspect system
 - Heavy duty top cast iron
 - Available LPG or Natural Gas
 - Adjustable legs
 - Easy to clean
 - Long life



GAST-DOCG2100-DLP



GAST-DOCG2100

- FR**
- Boitier en acier inoxydable
 - Soupape de sécurité avec thermocouple
 - Système d'inspection des incendies
 - La fonte en haute résistance
 - GPL disponible ou gaz naturel
 - Pieds réglable
 - Facile à nettoyer
 - Longue durée de vie



GAST-OCGK4150-DLP

KOD CODE	MODEL DESCRIPTION	EBATLAR DIMENSIONS	KG KG	GÜÇ POWER	DG SARFIYAT N.GAS EXPENDITURE	BASINÇ PRESSURE	FİYAT PRICE
GAST-DOCG2100	2 li Gazlı Ocak (Tab.Raf.Etr.Açık) Gas Cooker With Open Stand	1000 x 700 x 850	110 Kg.	14 kW	1,98 m ³	20 mbar	1.190 €
GAST-DOCG2100-DLP	2 li Dolaplı Ocak (Kapisız) Gas Cooker With Cupboard	1000 x 700 x 850	90 Kg.	14 kW	1,46 m ³	20 mbar	1.255 €
GAST-OCGK4100	4 lü Dolaplı Ocak (Kapisız) Gas Cooker With Cupboard	1000 x 1000 x 850	170 Kg.	28 kW	3,64 m ³	20 mbar	1.890 €
GAST-OCGK4100-DLP	4 lü Gazlı Ocak (Tab.Raf.Etr.Açık) Gas Cooker With Open Stand	1000 x 1000 x 850	150 Kg.	28 kW	2,91 m ³	20 mbar	1.825 €
GAST-OCGK4150	6 lü Dolaplı Ocak (Kapisız) Gas Cooker With Cupboard	1500 x 1000 x 850	190 Kg.	42 kW	5,10 m ³	20 mbar	2.455 €
GAST-OCGK4150-DLP	6 lü Gazlı Ocak (Tab.Raf.Etr.Açık) Gas Cooker With Open Stand	1500 x 1000 x 850	170 Kg.	42 kW	4,37 m ³	20 mbar	2.390 €

- TR**
- Paslanmaz çelik gövde
 - 30x30 cm 4 kW pik dökümlü pleytler
 - 6 kademeli kontrol edilebilir
 - Fırın ölçüleri GN 2/1–GN 1/1'e göre
 - Fırın sıcaklığı 50-300°C arası ayarlanabilir
 - Fırın içi rezistanslar alt ve üst olarak ayrı ayrı kontrol edilir
 - İzolasyonlu fırın
 - Alt ve üst bölüm 2 seyyar parçadan oluşur
 - Tencere devrilmelerini önlemek için yalpalıklar
 - Tencere büyüklüğüne göre ayarlanabilir yalpalıklar
 - Ayarlanabilir ve yere sabitlenebilir ayaklar

- EN**
- Stainless steel body
 - 30x30 cm 4 kW plate
 - Adjustable control system
 - Oven size is GN 2/1
 - Oven thermostat adjustment from 50°C to 300°C
 - For oven s work seperately or together
 - Isolated oven
 - Removable wire tray size GN 2/1
 - Upper and lower parts consists two portable tools
 - Holders can be adjusted according to the size of cookware
 - Roll holders to prevent tipping for cookware
 - Adjustable and fixed legs

- FR**
- Boîtier en acier inoxydable
 - Fonte à 30x30 cm plaques 4 kW
 - Contrôle à 3 niveaux
 - Dimensions du four selon GN 2/1–GN 1/1
 - Température réglable 50°C-300°C
 - Résistances contrôlables pour cuisson séparée
 - Isolation thermique
 - Le bas et le haut du four intérieure se compose de 2 pièces mobiles
 - Soutien des récipients por éviter le renversement
 - Soutien selon dimension de récipient
 - Pieds réglable et fixables au sol



GAST-MKZ493

KOD CODE	MODEL DESCRIPTION	EBATLAR DIMENSIONS	KG KG	GÜÇ POWER	ENERJİ ENERGY	FİYAT PRICE
GAST-MKZ270	2 li Kuzine Marin Marine Range	1000 x 700 x 850	120 Kg.	13 kW	400 V 3 ~ 50 Hz	-
GAST-MKZ370	3 lü Kuzine Marin Marine Range	1200 x 700 x 850	145 Kg.	17 kW	400 V 3 ~ 50 Hz	-
GAST-MKZ493	4 lü Kuzine Marin Marine Range	800 x 930 x 850	160 Kg.	-	400 V 3 ~ 50 Hz	3.950 €
GAST-MKZ470	4 lü Kuzine Marin Marine Range	800 x 700 x 850	105 Kg.	15,4 kW	400 V 3 ~ 50 Hz	2.290 €
GAST-MKZ4100	4 lü Kuzine Marin Marine Range	1000 x 1000 x 850	170 Kg.	21 kW	400 V 3 ~ 50 Hz	3.635 €



KOSAN OCAKLARI
FLOOR COOKER
Cusinière à Sol

ELEKTRİKLİ KOSAN OCAK / ELECTRIC STOVE / CUISINIÈRE ELECTRIQUE A SOL PG ⚡ CE

TR

- Paslanmaz çelik gövde
- Kolay temizlenebilir
- Pik dökümlü pleyt
- 6 kademeli kontrol edilebilir

FR

- Boitier en acier inoxydable
- Facile à nettoyer
- Fonte en fonte haute résistance
- Thermostat réglable

EN

- Stainless steel body
- Easy to clean
- Heavy duty top cast iron
- Adjustable thermostat



GAST-KO50

KOD CODE	MODEL DESCRIPTION	EBATLAR DIMENSIONS	KG KG	GÜÇ POWER	ENERJİ ENERGY	FİYAT PRICE
GAST-KO50	Elektrikli Kosan Ocak Electric Stove	500 x 500 x 550	24 Kg.	4 kW	400 V 3 ~ 60 Hz	750 €
GAST-KO500	Elektrikli Kosan Ocak Electric Stove	500 x 500 x 550	26 Kg.	5 kW	400 V 3 ~ 60 Hz	1.780 €

GAZLI KOSAN OCAK / GAS STOVE / CUISINIÈRE GAZ A SOL PG 🔥 CE

TR

- Paslanmaz çelik gövde
- Kolay temizlenebilir pislik tepsisi
- LPG ve Doğalgaza uyumlu
- Sanayi tipi döküm
- CE standartlarına uygun emniyet sistemli
- Alçak basınçta yüksek güç üretebilen brülör
- Zemine sabitlenebilme özelliği

EN

- Stainless steel body
- Easy to clean dirty tray
- Available LPG or Natural Gas
- Safety system
- Burners create high power is in the low pressure
- 60x60 or 70x70 industrial type cast iron
- Available fixed in ground



GAST-KOG600

FR

- Boitier en acier inoxydable
- Nettoyage facile
- Compatible au GPL et Gaz Naturel
- Fonte de type industriel
- Système de sécurité selon le standard de CE
- Sous basse pression, prudit haute puissance des brûleur
- Fonte de type industriel
- Fixable au sol



GAST-KOG700

KOD CODE	MODEL DESCRIPTION	EBATLAR DIMENSIONS	KG KG	GÜÇ POWER	DG SARFIYAT N.GAS EXPENDITURE	BASINÇ PRESSURE	FİYAT PRICE
GAST-KOG600	Gazlı Kosan Ocak Gas Stove	600 x 600 x 550	47 Kg.	24 kW	2,50 m ³	20 mbar	625 €
GAST-KOG700	Gazlı Kosan Ocak Gas Stove	700 x 700 x 550	59 Kg.	32 kW	3,33 m ³	20 mbar	870 €

WOK OCAK
WOK COOCKER
Cuiser Wok

TEKLİ WOK OCAK / WOK STOVE WITH 1 BURNER / CUISINIÈRE WOK



TR

- Paslanmaz çelik gövde
- Yüksek güçlü pik döküm brülör
- Alev denetleme tertibatı
- Pilot alev sistemi
- LPG ve doğalgaz uyumlu
- Kolay temizlenebilir
- Set üstü ve dolaplı kullanıma uygundur.



GAST-WK40

ÇİFTLİ WOK OCAK / WOK STOVE WITH 2 BURNERS / CUISINIÈRE WOK



EN

- Stainless steel
- High power cast iron
- Fire inspection system
- Pilot flame
- Available LPG or Natural Gas
- Easy to clean
- Available use over bench or cupboard



GAST-WK80

ÜÇLÜ WOK OCAK / WOK STOVE WITH 3 BURNERS / CUISINIÈRE WOK



FR

- Boîtier en acier inoxydable
- Thermocouple
- Dispositif de surveillance de flamme
- Fonte de type industriel
- Compatible au GPL / Gas naturel
- Nettoyage facile
- Utilisation sur planche ou armoire



GAST-WK120

KOD CODE	MODEL DESCRIPTION	EBATLAR DIMENSIONS	KG KG	GÜÇ POWER	DG SARFIYAT N.GAS EXPENDITURE	BASINÇ PRESSURE	FİYAT PRICE
GAST-WK40	Wok Ocak Wok Stove With 1 Burner	400 x 700 x 300	30 Kg.	18 kW	1,87 m ³	20 mbar	770 €
GAST-WK80	Wok Ocak Wok Stove With 2 Burners	800 x 700 x 300	56 Kg.	36 kW	3,74 m ³	20 mbar	1.245 €
GAST-WK120	Wok Ocak Wok Stove With 3 Burners	1200 x 700 x 300	82 Kg.	54 kW	5,61 m ³	20 mbar	1.755 €

FIRINLAR
OVENS
FourS



ELEKTRİKLİ PATİSSERİ FIRINI / ELECTRIC PASTE OVEN / FOUR A PATE ELECTRQUE PG ⚡ CE

- TR**
- Paslanmaz çelik gövde ve şase
 - Termostatik kontrol
 - Yüksek verimli elektrikli ısıtma sistemi
 - Kullanıcı tarafından sökülebilen çift camlı kapak sistemi ile temizlik imkanı
 - Kapağın kapatılmasıyla başlayan pişirme döngüsü
 - Güvenliği sağlayan emniyet termostatu
 - Temizlik kolaylığı sunan fırın kabin tasarımı
 - Kullanıcı dostu kumanda ara yüzü
 - Aydınlatma lambalı pişirme kabini
 - İki yönlü fan sistemi ile kusursuz pişirme

- EN**
- Stainless steel chasis construction
 - Thermostatically controlled
 - Highly efficient electric heating system
 - Double-glazed removable door system allows to clean it by the user
 - Cooking cycle start at door closing
 - Safety thermostat provides security
 - Interior design provides ease of cleaning
 - User-friendly command interface
 - Cooking cabinet with lighting lamb
 - Perfect cooking with clockwise-anticlockwise fan system
 - Water connection allows to cooking foods with humidity (optional)

- FR**
- Construction de châssis en acier inoxydable
 - Contrôlé par thermostat
 - Système de chauffage électrique très efficace
 - Le système de porte amovible à double vitrage permet son nettoyage par l'utilisateur
 - Début du cycle de cuisson à la fermeture de la porte
 - Le thermostat de sécurité assure la sécurité
 - La conception intérieure facilite le nettoyage
 - Interface de commande conviviale
 - Meuble de cuisson avec éclairage agneau
 - Cuisson parfaite avec système de ventilation dans le sens des aiguilles d'une montre et dans le sens inverse des aiguilles d'une montre



GAST-PF3

KOD CODE	MODEL DESCRIPTION	EBATLAR DIMENSIONS	KG KG	RAFTİPİ SHELF TYPE	GÜÇ POWER	ENERJİ ENERGY	FİYAT PRICE
GAST-PF3	3 Tepsili Konveksiyonel Fırın 3 Trays Convection Oven	560 x 710 x 510	42 Kg.	GN 2/3 / 25 x 35	3 kW	220 V 1 ~ 50 Hz	1.440 €
GAST-PF4	4 Tepsili Konveksiyonel Fırın 4 Trays Convection Oven	810 x 800 x 600	72 Kg.	600 x 400	4,5 kW	220 V 1 ~ 50 Hz	2.095 €
GAST-PF4P	4 Tepsili Konveksiyonel Fırın 4 Trays Convection Oven	970 x 810 x 630	77 Kg.	600 x 400	4,7 kW	220 V 1 ~ 50 Hz	2.230 €
GAST-PF4PD	4 Tepsili Dijital Konveksiyonel Fırın 4 Trays Digital Convection Oven	970 x 810 x 630	77 Kg.	600 x 400	4,7 kW	220 V 1 ~ 50 Hz	2.960 €
GAST-PF6	6 Tepsili Konveksiyonel Fırın 6 Trays Convection Oven	870 x 870 x 890	96 Kg.	600 x 400	9,5 kW	380 V 3 ~ 50 Hz	3.830 €
GAST-PF6D	6 Tepsili Dijital Konveksiyonel Fırın 6 Trays Digital Convection Oven	870 x 870 x 890	96 Kg.	600 x 400	9,5 kW	380 V 3 ~ 50 Hz	4.790 €
GAST-PF6G	4 Tepsili Gazlı Konveksiyonel Fırın 4 Trays Gaseous Convection Oven	860 x 1280 x 990	165 Kg.	600 x 400	1 kW	380 V 3 ~ 50 Hz	4.595 €
GAST-PM10	Mayalama Dolabı Fermentation Cabinet	930 x 760 x 850	63 Kg.	600 x 400	-	200 V 3 ~ 50 Hz	1.810 €

ELEKTRİKLİ PATİSSERİ FIRINI / ELECTRIC PASTE OVEN / FOUR A PATE ELECTRQUE



- TR**
- Paslanmaz çelik gövde ve şase
 - Termostatik kontrol
 - Yüksek verimli elektrikli ısıtma sistemi
 - Kullanıcı tarafından sökülebilen çift camlı kapak sistemi ile temizlik imkanı
 - Kapağın kapatılmasıyla başlayan pişirme döngüsü
 - Güvenliği sağlayan emniyet termostatu
 - Temizlik kolaylığı sunan fırın kabin tasarımı
 - Kullanıcı dostu kumanda ara yüzü
 - Aydınlatma lambalı pişirme kabini
 - İki yönlü fan sistemi ile kusursuz pişirme

- EN**
- Stainless steel chasis construction
 - Thermostatically controlled
 - Highly efficient electric heating system
 - Double-glazed removable door system allows to clean it by the user
 - Cooking cycle start at door closing
 - Safety thermostat provides security
 - Interior design provides ease of cleaning
 - User-friendly command interface
 - Cooking cabinet with lighting lamb
 - Perfect cooking with clockwise-anticlockwise fan system
 - Water connection allows to cooking foods with humidity (optional)

- FR**
- Construction de châssis en acier inoxydable
 - Contrôlé par thermostat
 - Système de chauffage électrique très efficace
 - Le système de porte amovible à double vitrage permet son nettoyage par l'utilisateur
 - Début du cycle de cuisson à la fermeture de la porte
 - Le thermostat de sécurité assure la sécurité
 - La conception intérieure facilite le nettoyage
 - Interface de commande conviviale
 - Meuble de cuisson avec éclairage agneau
 - Cuisson parfaite avec système de ventilation dans le sens des aiguilles d'une montre et dans le sens inverse des aiguilles d'une montre



GAST-PF10



KOD CODE	MODEL DESCRIPTION	EBATLAR DIMENSIONS	KG KG	RAF TİPİ SHELF TYPE	GÜÇ POWER	ENERJİ ENERGY	FİYAT PRICE
GAST-PF10	10 Tepsili Konveksiyonel Fırın 10 Trays Convection Oven	940 x 870 x 1210	130 Kg.	600 x 400	13,5 kW	380 V 3 ~ 50 Hz	5.430 €
GAST-PF10D	10 Tepsili Dijital Konveksiyonel Fırın 10 Trays Digital Convection Oven	940 x 870 x 1210	130 Kg.	600 x 400	13,5 kW	380 V 3 ~ 50 Hz	6.160 €
GAST-PF10G	10 Tepsili Gazlı Konveksiyonel Fırın 10 Trays Gaseous Convection Oven	860 x 1280 x 1190	180 Kg.	600 x 400	16 kW	380 V 3 ~ 50 Hz	5.990 €
GAST-DPF10	10 Döner Tepsili Konveksiyonel Fırın 10 Rotary Trays Convection Oven	1100 x 1470 x 1600	275 Kg.	600 x 400	28 kW	380 V 3 ~ 50 Hz	12.575 €
GAST-GF20E	20 Tepsili Konveksiyonel Fırın 20 Trays Convection Oven	950 x 1280 x 990	171 Kg.	2/1 Gastronomi	16 kW	380 V 3 ~ 50 Hz	6.515 €
GAST-GF20G	20 Tepsili Gazlı Konveksiyonel Fırın 20 Trays Gaseous Convection Oven	950 x 1280 x 990	171 Kg.	2/1 Gastronomi	1	380 V 3 ~ 50 Hz	7.155 €
GAST-GF40E	40 Tepsili Konveksiyonel Fırın 40 Trays Convection Oven	950 x 1280 x 1800	257 Kg.	2/1 Gastronomi	32 kW	380 V 3 ~ 50 Hz	10.240 €
GAST-GF40G	40 Tepsili Gazlı Konveksiyonel Fırın 40 Trays Gaseous Convection Oven	950 x 1280 x 1800	257 Kg.	2/1 Gastronomi	1,75 kW	380 V 3 ~ 50 Hz	10.905 €

PIZZA FIRINLARI
PIZZA OVENS
Four a Pizza



ELEKTRİKLİ PİZZA FIRINI / ELECTRIC PIZZA OVEN / FOUR A PIZZA ELECTRQUE



- TR**
- Oluşan buharın atılması için havalandırma delikli
 - Fırının tamamı 6 cm kalınlığında kaya yünü izolasyonlu
 - Ön yüz komple paslanmaz çelikten, gövde fırın boyalı
 - 50°- 450°C arası termostatlı ısı kontrolü, EGO marka termostat
 - İç aydınlatma lambalı
 - 400 V üç fazlı ve 230 V tek fazlı elektrik sistemi
 - Termometreli PBT ve termometresiz PB modeller
 - Ön kapakta geniş ısıya dayanıklı cam pencere
 - 20 mm kalınlığında refraktör pişirme taşı
 - Ön kapaklarda kuvvetli yay mekanizması
 - Bağımsız kat kontrolü

- EN**
- Optimal cooking with ventilation hole
 - All surfaces are insulated by 6 cm thickness of rock wool
 - Stainless steel heating elements
 - Temperature control between 50°C–450°C is provided by EGO brand thermostat
 - Interior lighting
 - 230 V single phase / 400 V three phase are optional
 - PB-T models with thermometer and PB models without thermometer
 - Extra large heat proof glass door
 - Refractory stone thickness: 20 mm
 - Spring mechanism on doors
 - Separate control for each deck

- FR**
- Cuisson optimale avec trou de ventilation
 - Toutes les surfaces sont isolées par 6 cm d'épaisseur de laine de roche
 - Éléments chauffants en acier inoxydable
 - Le contrôle de la température entre 50°C et 450°C est assuré par le thermostat de marque EGO
 - L'éclairage intérieur
 - 230 V monophasé / 400 V triphasé en option
 - Modèles PB-T avec thermomètre et modèles PB sans thermomètre
 - Très grande porte en verre résistant à la chaleur
 - Épaisseur de pierre réfractaire: 20 mm
 - Mécanisme à ressort sur les portes
 - Contrôle séparé pour chaque étage



GAST-P510



GAST-PC510

KOD CODE	MODEL DESCRIPTION	EBATLAR DIMENSIONS	KG KG	İÇ ÖLÇÜLER INNER DIMENSIONS	GÜÇ POWER	ENERJİ ENERGY	FİYAT PRICE
GAST-P510	4 lü Elektrikli Pizza Fırını Electric Pizza Oven With 4	810 x 710 x 360	55Kg.	510 x 510 x 100	4 kW	220V 1 ~ 50 Hz	985 €
GAST-P510G	4 lü Elektrikli Göstergeli Pizza Fırını 4 Electric Pizza Oven With Indicator	810 x 710 x 360	55 Kg.	510 x 510 x 100	4 kW	220V 1 ~ 50 Hz	1095 €
GAST-PC510	8 li Elektrikli Çift Katlı Pizza Fırını Electric Double Deck Pizza Oven With 8	780 x 710 x 530	80 Kg.	2 x 510 x 510 x 100	6 kW	380V 3 ~ 50 Hz	1.395€
GAST-PC510G	8 li Elektrikli Çift Katlı Göstergeli Pizza Fırını Electric Double Deck Pizza Oven With Indicator 4	780 x 710 x 530	80 Kg.	2 x 510 x 510 x 100	6 kW	380V 3 ~ 50 Hz	1.585 €
GAST-P610	4 lü Elektrikli Pizza Fırını Electric Pizza Oven With 4	910 x 810 x 450	80 Kg.	615 x 615 x 150	5 kW	380V 3 ~ 50 Hz	1.235 €
GAST-P610G	4 lü Elektrikli Göstergeli Pizza Fırını Electric Pizza Oven With Indicator 4	910 x 810 x 450	80 Kg.	615 x 615 x 150	5 kW	380V 3 ~ 50 Hz	1.345 €
GAST-PC610	8 li Elektrikli Çift Katlı Pizza Fırını 8 Electric Double Deck Pizza Oven	910 x 810 x 780	135 Kg.	2 x 615 x 615 x 150	10 kW	380V 3 ~ 50 Hz	2.080 €
GAST-PC610G	8 li Elektrikli Göstergeli Çift Katlı Pizza Fırını 8-layer Double Deck Pizza Oven with Electric Display	910 x 810 x 780	135 Kg.	2 x 615 x 615 x 150	10 kW	380V 3 ~ 50 Hz	2.300 €

ELEKTRİKLİ PİZZA FIRINI / ELECTRIC PIZZA OVEN / FOUR A PIZZA ELECTRQUE

- TR**
- Oluşan buharın atılması için havalandırma delikli
 - Fırının tamamı 6 cm kalınlığında kaya yünü izolasyonlu
 - Ön yüz komple paslanmaz çelikten, gövde fırın boyalı
 - 50°- 450°C arası termostatlı ısı kontrolü, EGO marka termostat
 - İç aydınlatma lambalı
 - 400 V üç fazlı ve 230 V tek fazlı elektrik sistemi
 - Termometreli PBT ve termometresiz PB modeller
 - Ön kapakta geniş ısıya dayanıklı cam pencere
 - 20 mm kalınlığında refraktör pişirme taşı
 - Ön kapaklarda kuvvetli yay mekanizması
 - Bağımsız kat kontrolü

- EN**
- Optimal cooking with ventilation hole
 - All surfaces are insulated by 6 cm thickness of rock wool
 - Stainless steel heating elements
 - Temperature control between 50°C–450°C is provided by EGO brand thermostat
 - Interior lighting
 - 230 V single phase / 400 V three phase are optional
 - PB-T models with thermometer and PB models without thermometer
 - Extra large heat proof glass door
 - Refractory stone thickness: 20 mm
 - Spring mechanism on doors
 - Separate control for each deck

- FR**
- Cuisson optimale avec trou de ventilation
 - Toutes les surfaces sont isolées par 6 cm d'épaisseur de laine de roche
 - Éléments chauffants en acier inoxydable
 - Le contrôle de la température entre 50°C et 450°C est assuré par le thermostat de marque EGO
 - L'éclairage intérieur
 - 230 V monophasé / 400 V triphasé en option
 - Modèles PB-T avec thermomètre et modèles PB sans thermomètre
 - Très grande porte en verre résistant à la chaleur
 - Épaisseur de pierre réfractaire: 20 mm
 - Mécanisme à ressort sur les portes
 - Contrôle séparé pour chaque étage



GAST-PC920



GAST-P920

KOD CODE	MODEL DESCRIPTION	EBATLAR DIMENSIONS	KG KG	İÇ ÖLÇÜLER INNER DIMENSIONS	GÜÇ POWER	ENERJİ ENERGY	FİYAT PRICE
GAST-P920	6 lı Elektrikli Pizza Fırını Electric Pizza Oven With 6	1220 x 810 x 450	100 Kg.	920 x 615 x 150	6 kW	380 V 3 ~ 50 Hz	1.490 €
GAST-P920G	6 lı Elektrikli Göstergeli Pizza Fırını Electric Pizza Oven With Indicator 6	1220 x 810 x 450	100 Kg.	920 x 615 x 150	6 kW	380 V 3 ~ 50 Hz	1.600 €
GAST-PC920	12 lı Elektrikli Çift Katlı Pizza Fırını Electric Double Deck Pizza Oven With 12	1220 x 810 x 770	170 Kg.	2 x 920 x 615 x 150	12 kW	380 V 3 ~ 50 Hz	2.745 €
GAST-PC920G	12 lı Elektrikli Çift Katlı Göstergeli Pizza Fırını Electric Double Deck Pizza Oven With Indicator 12	1220 x 810 x 770	170 Kg.	2 x 920 x 615 x 150	12 kW	380 V 3 ~ 50 Hz	2.960 €
GAST-GP920	9 lu Elektrikli Pizza Fırını Electric Pizza Oven With 9	1220 x 1100 x 450	133 Kg.	920 x 920 x 150	8 kW	380 V 3 ~ 50 Hz	2.385 €
GAST-GP920G	9 lu Elektrikli Göstergeli Pizza Fırını Electric Pizza Oven With Indicator 9	1220 x 1100 x 450	133 Kg.	920 x 920 x 150	8 kW	380 V 3 ~ 50 Hz	2.495 €
GAST-GPC920	18 lı Elektrikli Çift Katlı Pizza Fırını Electric Double Deck Pizza Oven With 18	1220 x 1100 x 770	220 Kg.	2 x 920 x 920 x 150	16 kW	380 V 3 ~ 50 Hz	3.795 €
GAST-GPC920G	18 lı Elektrikli Çift Katlı Göstergeli Pizza Fırını Electric Double Deck Pizza Oven With Indicator 18	1220 x 1100 x 770	220 Kg.	2 x 920 x 920 x 150	16 kW	380 V 3 ~ 50 Hz	4.015 €

SOĞUK ÜNİTELER

COLD UNITS

Unités Froides

TEZGAH TİPİ BUZDOLABI / REFRIGERATORS COUNTER / DESSERTÉ RÉFRIGÉRÉ

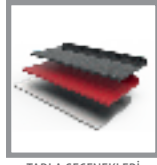
CAM KAPI
GLASS DOORÇEKMECE
DRAWERPAZLANMAZ RAF
S.S. SHELFTABLA ŞEÇENEKLERİ
KIND OF TOPSKİLİT
LOCKTEKERLEK
WHEEL

TR

- Dış ortam sıcaklığı +43°C %65 nem oranı
- Eşit sıcaklık dağılımı için yeni tasarım
- Sıfır ODP enjekte 42 kg/m3 çevre dostu poliüretan izolasyon
- Elektrikli otomatik defrost
- Kolay okunur ekranlı dijital kontrol
- Ergonomik kapı ve kulpu sayesinde kolay açılma ve temizlik
- Patentli 'Icecool' soğutma sistemi ile mükemmel verim ve enerji sarfıyatı
- Sıcak gaz defrost sistemi
- Atık ısı geri kazanımlı kondanzasyon
- Tüm buzdolapların marine versiyonları mevcuttur.
- Marine versiyonları 'Icecool marine' sistemi, marine ayak ve raflar içerir.

EN

- Outdoor temperature +43°C 65% humidity
- New design for even temperature distribution
- Zero ODP injected 42 kg/m3 environmentally friendly polyurethane insulation
- Electric automatic defrost
- Digital control with easy-to-read display
- Easy opening and cleaning thanks to ergonomic door and handle
- Excellent efficiency and energy consumption with patented 'Icecool' cooling system
- Hot gas defrosting system
- Condensation with waste heat recovery
- All refrigerators are available in marine versions.
- Marine versions include the 'Icecool marine' system, marine feet and shelves.



TEZGAH TİPİ BUZDOLABI / REFRIGERATORS COUNTER WITH / DESSERTE RÉFRIGÉRÉ



1/2 Çekmece
1/2 Drawers

490 €



1/3 Çekmece
1/3 Drawers

625 €



Dolap Kilidi
Cabinet Lock

75 €

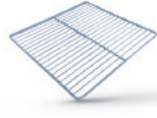

Raf ve Raf Kızağı
Shelf and Shelf Holder

55 €



Sol Motor
Left Motor

35 €



Tekerlekli
Wheels

95 €





Cam Kapı
Glass Door

240 €

Granit Üst Tabla Granite Work Top	Kapı Door	Fiyat Price
	2	780 €
	3	1.132 €
	4	1.305 €

Polietilen Üst Tabla Polyethylene Work Top	Kapı Door	Fiyat Price
	2	740 €
	3	980 €
	4	1.250 €

Mermer Üst Tabla Marble Work Top	Kapı Door	Fiyat Price
	2	390 €
	3	505 €
	4	655 €

Üst Tablasız Without Table Top	Kapı Door	P.kalite S.S Quality	Fiyat Price
	2	304	-175 €
	2	430	-90 €
	3	304	-195 €
	3	430	-100 €
	4	304	-215 €
	4	430	-160 €



KOD CODE	SICAKLIK TEMP.	EBATLAR DIMENSIONS	KAPI DOOR	LİTRE LITER	GÜÇ POWER	VOLTAJ VOLTAGE	P. KALİTE S.S QLTY	KG KG	FİYAT PRICE
GAST-TTB1200	-2 / +8	150X60X85	2	275 LT	461 W	230 V / 50 Hz	304	95 Kg	2.520 €
GAST-TTB1200C	-2 / +8	150X60X85	2	275 LT	461 W	230 V / 50 Hz	430	95 Kg	2.070 €
GAST-TTD1200	-10 / -22	150X60X85	2	275 LT	733 W	230 V / 50 Hz	304	95 Kg	3.210 €
GAST-TTD1200C	-10 / -22	150X60X85	2	275 LT	733 W	230 V / 50 Hz	430	95 Kg	2.655 €
GAST-TTGB1200	-2 / +8	150X70X85	2	330 LT	461 W	230 V / 50 Hz	304	100 Kg	2.615 €
GAST-TTGB1200C	-2 / +8	150X70X85	2	330 LT	461 W	230 V / 50 Hz	430	100 Kg	2.100 €
GAST-TTGD1200	-10 / -22	150X70X85	2	330 LT	733 W	230 V / 50 Hz	304	100 Kg	3.395 €
GAST-TTGD1200C	-10 / -22	150X70X85	2	330 LT	733 W	230 V / 50 Hz	430	100 Kg	2.760 €
GAST-TTB1300	-2 / +8	200X60X85	3	440 LT	665 W	230 V / 50 Hz	304	127 Kg	2.985 €
GAST-TTB1300C	-2 / +8	200X60X85	3	440 LT	665 W	230 V / 50 Hz	430	127 Kg	2.375 €
GAST-TTD1300	-10 / -22	200X60X85	3	440 LT	733 W	230 V / 50 Hz	304	127 Kg	3.945 €
GAST-TTD1300C	-10 / -22	200X60X85	3	440 LT	733 W	230 V / 50 Hz	430	127 Kg	3.315 €
GAST-TTGB1300	-2 / +8	200X70X85	3	515 LT	665 W	230 V / 50 Hz	304	135 Kg	3.050 €
GAST-TTGB1300C	-2 / +8	200X70X85	3	515 LT	665 W	230 V / 50 Hz	430	135 Kg	2.525 €
GAST-TTGD1300	-10 / -22	200X70X85	3	515 LT	733 W	230 V / 50 Hz	304	135 Kg	3.995 €
GAST-TTGD1300C	-10 / -22	200X70X85	3	515 LT	733 W	230 V / 50 Hz	430	135 Kg	3.430 €
GAST-TTB1400	-2 / +8	250X60X85	4	560 LT	765 W	230 V / 50 Hz	304	187 Kg	3.605 €
GAST-TTB1400C	-2 / +8	250X60X85	4	560 LT	765 W	230 V / 50 Hz	430	187 Kg	2.965 €
GAST-TTD1400	-10 / -22	250X60X85	4	560 LT	733 W	230 V / 50 Hz	304	187 Kg	5.335 €
GAST-TTD1400C	-10 / -22	250X60X85	4	560 LT	733 W	230 V / 50 Hz	430	187 Kg	4.665 €
GAST-TTGB1400	-2 / +8	250X70X85	4	650 LT	765 W	230 V / 50 Hz	304	195 Kg	3.740 €
GAST-TTGB1400C	-2 / +8	250X70X85	4	650 LT	765 W	230 V / 50 Hz	430	195 Kg	3.160 €
GAST-TTGD1400	-10 / -22	250X70X85	4	650 LT	733 W	230 V / 50 Hz	304	195 Kg	5.410 €
GAST-TTGD1400C	-10 / -22	250X70X85	4	650 LT	733 W	230 V / 50 Hz	430	195 Kg	4.780 €

TEZGAH TİPİ BUZDOLABI CAM KAPILI / REFRIGERATORS COUNTER WITH GLASS DOOR / DESERTE RÉFRIGÉRE

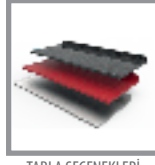
CAM KAPI
GLASS DOORÇEKMECE
DRAWERPAZLANMAZ RAF
S.S. SHELFTABLA SEÇENEKLERİ
KIND OF TOPSKİLİT
LOCKTEKERLEK
WHEEL

TR

- Dış ortam sıcaklığı +43°C %65 nem oranı
- Eşit sıcaklık dağılımı için yeni tasarım
- Sıfır ODP enjekte 42 kg/m³ çevre dostu poliüretan izolasyon
- Elektrikli otomatik defrost
- Kolay okunur ekranlı dijital kontrol
- Ergonomik kapı ve kulpu sayesinde kolay açılma ve temizlik
- Patentli 'Icecool' soğutma sistemi ile mükemmel verim ve enerji sarfıyatı
- Sıcak gaz defrost sistemi
- Atık ısı geri kazanımlı kondanzasyon
- Tüm buzdolapların marine versiyonları mevcuttur.
- Marine versiyonları 'Icecool marine' sistemi, marine ayak ve raflar içerir.

EN

- Outdoor temperature +43°C 65% humidity
- New design for even temperature distribution
- Zero ODP injected 42 kg/m³ environmentally friendly polyurethane insulation
- Electric automatic defrost
- Digital control with easy-to-read display
- Easy opening and cleaning thanks to ergonomic door and handle
- Excellent efficiency and energy consumption with patented 'Icecool' cooling system
- Hot gas defrosting system
- Condensation with waste heat recovery
- All refrigerators are available in marine versions.
- Marine versions include the 'Icecool marine' system, marine feet and shelves.

TEZGAH TİPİ BUZDOLABI CAM KAPILI / REFRIGERATORS COUNTER WITH GLASS DOOR / DESSERTÉ RÉFRIGÉRÉ



1/2 Çekmece
1/2 Drawers

490 €



1/3 Çekmece
1/3 Drawers

625 €



Dolap Kilidi
Cabinet Lock

75 €

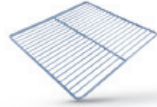

Raf ve Raf Kızağı
Shelf and Shelf Holder

55 €



Sol Motor
Left Motor

35 €



Tekerlekli
Wheels

95 €



Cam Kapi
Glass Door

240 €

Granit Üst Tabla
Granite Work Top



Kapı
Door

2
3
4

Fiyat
Price

780 €
1.132 €
1.305 €

Polietilen Üst Tabla
Polyethylene Work Top



Kapı
Door

2
3
4

Fiyat
Price

740 €
980 €
1.250 €

Mermer Üst Tabla
Marble Work Top



Kapı
Door

2
3
4

Fiyat
Price

390 €
505 €
655 €

Üst Tablasız
Without Table Top



Kapı P.kalite
Door S.S Quality

2
3
4

Fiyat
Price

304
430
304
430

-175 €
-90 €
-195 €
-100 €
-215 €
-160 €



KOD CODE	SICAKLIK TEMP.	EBATLAR DIMENSIONS	KAPI DOOR	LİTRE LITER	GÜÇ POWER	VOLTAJ VOLTAGE	P. KALİTE S.S QLTY	KG KG	FİYAT PRICE
GAST-TTCB1200	-2 / +8	150X60X85	2	275 LT	461 W	230 V / 50 Hz	304	95 Kg	2.965 €
GAST-TTCB1200C	-2 / +8	150X60X85	2	275 LT	461 W	230 V / 50 Hz	430	95 Kg	2.510 €
GAST-TTCGB1200	-2 / +8	150X70X85	2	330 LT	461 W	230 V / 50 Hz	304	100 Kg	3.065 €
GAST-TTCGB1200C	-2 / +8	150X70X85	2	330 LT	461 W	230 V / 50 Hz	430	100 Kg	2.540 €
GAST-TTCB1300	-2 / +8	200X60X85	3	440 LT	665 W	230 V / 50 Hz	304	127 Kg	3.655 €
GAST-TTCB1300C	-2 / +8	200X60X85	3	440 LT	665 W	230 V / 50 Hz	430	127 Kg	3.035 €
GAST-TTCGB1300	-2 / +8	200X70X85	3	515 LT	665 W	230 V / 50 Hz	304	135 Kg	3.720 €
GAST-TTCGB1300C	-2 / +8	200X70X85	3	515 LT	665 W	230 V / 50 Hz	430	135 Kg	3.140 €
GAST-TTCB1400	-2 / +8	250X60X85	4	560 LT	765 W	230 V / 50 Hz	304	187 Kg	4.500 €
GAST-TTCB1400C	-2 / +8	250X60X85	4	560 LT	765 W	230 V / 50 Hz	430	187 Kg	3.845 €
GAST-TTCGB1400	-2 / +8	250X70X85	4	650 LT	765 W	230 V / 50 Hz	304	195 Kg	4.640 €
GAST-TTCGB1400C	-2 / +8	250X70X85	4	650 LT	765 W	230 V / 50 Hz	430	195 Kg	3.955 €

EVYELİ TEZGAH TİPİ BUZDOLABI / REFRIGERATORS COUNTER WITH SINK / DESSERTÉ RÉFRIGÉRÉ



CAM KAPI
GLASS DOOR



ÇEKMECE
DRAWER



PAZLANMAZ RAF
S.S. SHELF



TABLA ŞEÇENEKLERİ
KIND OF TOPS



KİLİT
LOCK

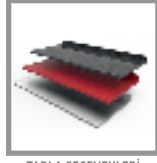

TEKERLEK
WHEEL



TR

- Dış ortam sıcaklığı +43°C %65 nem oranı
- Eşit sıcaklık dağılımı için yeni tasarım
- Sıfır ODP enjekte 42 kg/m3 çevre dostu poliüretan izolasyon-
- Elektrikli otomatik defrost
- Kolay okunur ekranlı dijital kontrol
- Ergonomik kapı ve kulpu sayesinde kolay açılma ve temizlik
- Patentli 'Icecool' soğutma sistemi ile mükemmel verim ve enerji sarfıyatı
- Sıcak gaz defrost sistemi
- Atık ısı geri kazanımlı kondanzasyon
- Tüm buzdolapların marine versiyonları mevcuttur.
- Marine versiyonları 'Icecool marine' sistemi, marine ayak ve raflar içerir.

EN

- Outdoor temperature +43°C 65% humidity
- New design for even temperature distribution
- Zero ODP injected 42 kg/m3 environmentally friendly polyurethane insulation
- Electric automatic defrost
- Digital control with easy-to-read display
- Easy opening and cleaning thanks to ergonomic door and handle
- Excellent efficiency and energy consumption with patented 'Icecool' cooling system
- Hot gas defrosting system
- Condensation with waste heat recovery
- All refrigerators are available in marine versions.
- Marine versions include the 'Icecool marine' system, marine feet and shelves.

EVYELİ TEZGAH TİPİ BUZDOLABI / REFRIGERATORS COUNTER WITH SINK / DESERTE RÉFRIGÉRÉ

1/2 Çekmece
1/2 Drawers

490 €

1/3 Çekmece
1/3 Drawers

625 €

Dolap Kilidi
Cabinet Lock

75 €

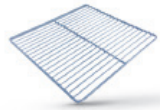
Raf ve Raf Kızağı
Shelf and Shelf Holder

55 €

Sol Motor
Left Motor

35 €

Tekerlekli
Wheels

95 €

Cam Kapı
Glass Door

240 €



KOD CODE	SICAKLIK TEMP.	EBATLAR DIMENSIONS	KAPI DOOR	LİTRE LITER	GÜÇ POWER	VOLTAJ VOLTAGE	TÜKETİM CONSUMPTION	P. KALİTE S.S QLTY	KG KG	FİYAT PRICE
GAST-TTEB1200	-2 / +8	150X60X85	2	275 LT	461 W	230 V / 50 Hz	0,321 kW 1,93 A	304	95 Kg	3020 €
GAST-TTEB1200C	-2 / +8	150X60X85	2	275 LT	461 W	230 V / 50 Hz	0,321 kW 1,93 A	430	95 Kg	2.895 €
GAST-TTEB1210	-2 / +8	150X70X85	2	330 LT	461 W	230 V / 50 Hz	0,321 kW 1,93 A	304	100 Kg	3.095 €
GAST-TTEB1210C	-2 / +8	150X70X85	2	330 LT	461 W	230 V / 50 Hz	0,321 kW 1,93 A	430	100 Kg	2.955 €
GAST-TTEB1300	-2 / +8	200X60X85	3	440 LT	665 W	230 V / 50 Hz	0,336 kW 1,98 A	304	127 Kg	3.730 €
GAST-TTEB1300C	-2 / +8	200X60X85	3	440 LT	665 W	230 V / 50 Hz	0,336 kW 1,98 A	430	127 Kg	3.545 €
GAST-TTEB1310	-2 / +8	200X70X85	3	515 LT	665 W	230 V / 50 Hz	0,336 kW 1,98 A	304	135 Kg	3.805 €
GAST-TTEB1310C	-2 / +8	200X70X85	3	515 LT	665 W	230 V / 50 Hz	0,336 kW 1,98 A	430	135 Kg	3.615 €
GAST-TTEB1400	-2 / +8	250X60X85	4	560 LT	765 W	230 V / 50 Hz	0,501 kW 3,50 A	304	187 Kg	4.365 €
GAST-TTEB1400C	-2 / +8	250X60X85	4	560 LT	765 W	230 V / 50 Hz	0,501 kW 3,50 A	430	187 Kg	4.170 €
GAST-TTEB1410	-2 / +8	250X70X85	4	650 LT	765 W	230 V / 50 Hz	0,501 kW 3,50 A	304	195 Kg	4.385 €
GAST-TTEB1410C	-2 / +8	250X70X85	4	650 LT	765 W	230 V / 50 Hz	0,501 kW 3,50 A	430	195 Kg	4.185 €

CİHAZ ALTI BUZDOLAPLARI / UNDERCOUNTER REFRIGERATORS / RÉFRIGÉRATEUR SOUS LE COMPTOIR

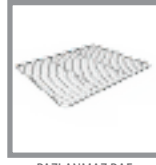
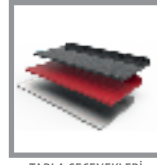
CAM KAPI
GLASS DOORÇEKMECE
DRAWERPAZLANMAZ RAF
S.S. SHELFTABLA SEÇENEKLERİ
KIND OF TOPSKİLİT
LOCKTEKERLEK
WHEEL

TR

- Dış ortam sıcaklığı +43°C %65 nem oranı
- Eşit sıcaklık dağılımı için yeni tasarım
- Sıfır ODP enjekte 42 kg/m3 çevre dostu poliüretan izolasyon
- Elektrikli otomatik defrost
- Kolay okunur ekranlı dijital kontrol
- Ergonomik kapı ve kulpu sayesinde kolay açılma ve temizlik
- Patentli 'Icecool' soğutma sistemi ile mükemmel verim ve enerji sarfıyatı
- Sıcak gaz defrost sistemi
- Atık ısı geri kazanımlı kondanzasyon
- Tüm buzdolapların marine versiyonları mevcuttur.
- Marine versiyonları 'Icecool marine' sistemi, marine ayak ve raflar içerir.

EN

- Outdoor temperature +43°C 65% humidity
- New design for even temperature distribution
- Zero ODP injected 42 kg/m3 environmentally friendly polyurethane insulation
- Electric automatic defrost
- Digital control with easy-to-read display
- Easy opening and cleaning thanks to ergonomic door and handle
- Excellent efficiency and energy consumption with patented 'Icecool' cooling system
- Hot gas defrosting system
- Condensation with waste heat recovery
- All refrigerators are available in marine versions.
- Marine versions include the 'Icecool marine' system, marine feet and shelves.

CİHAZ ALTI BUZDOLAPLARI / UNDERCOUNTER REFRIGERATORS / RÉFRIGÉRATEUR SOUS LE COMPTOIR



1/2 Çekmece
1/2 Drawers

450 €



1/1 Çekmece
1/1 Drawers

345 €



Dolap Kilidi
Cabinet Lock

75 €

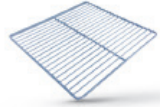

Raf ve Raf Kızağı
Shelf and Shelf Holder

55 €



Sol Motor
Left Motor

35 €



Tekerlekli
Wheels

95 €



Cam Kapı
Glass Door

240 €



Üst Tablasız
Without Table Top



Kapı P.kalite Door S.S Quality	Fiyat Price
2 304	-175 €
2 430	-90 €
3 304	-195 €
3 430	-100 €
4 304	-215 €
4 430	-160 €

KOD CODE	SICAKLIK TEMP.	EBATLAR DIMENSIONS	KAPI DOOR	LİTRE LITER	GÜÇ POWER	VOLTAJ VOLTAGE	P. KALİTE S.S QLTY	KG KG	FİYAT PRICE
GAST-PAB1200	-2 / +8	140X60X60	2	190 LT	461 W	230 V / 50 Hz	304	90 Kg	2.270 €
GAST-PAB1200C	-2 / +8	140X60X60	2	190 LT	461 W	230 V / 50 Hz	430	90 Kg	2.175 €
GAST-PAD1200	-10 / -22	140X60X60	2	190 LT	733 W	230 V / 50 Hz	304	90 Kg	3.245 €
GAST-PAD1200C	-10 / -22	140X60X60	2	190 LT	733 W	230 V / 50 Hz	430	90 Kg	3.135 €
GAST-PAGB1200	-2 / +8	140X70X60	2	220 LT	461 W	230 V / 50 Hz	304	95 Kg	2.350 €
GAST-PAGB1200C	-2 / +8	140X70X60	2	220 LT	461 W	230 V / 50 Hz	430	95 Kg	2.215 €
GAST-PAGD1200	-10 / -22	140X70X60	2	220 LT	733 W	230 V / 50 Hz	304	95 Kg	3.265 €
GAST-PAGD1200C	-10 / -22	140X70X60	2	220 LT	733 W	230 V / 50 Hz	430	95 Kg	3.150 €
GAST-PAB1300	-2 / +8	200X60X60	3	280 LT	665 W	230 V / 50 Hz	304	120 Kg	2.720 €
GAST-PAB1300C	-2 / +8	200X60X60	3	280 LT	665 W	230 V / 50 Hz	430	120 Kg	2.570 €
GAST-PAD1300	-10 / -22	200X60X60	3	280 LT	733 W	230 V / 50 Hz	304	120 Kg	3.535 €
GAST-PAD1300C	-10 / -22	200X60X60	3	280 LT	733 W	230 V / 50 Hz	430	120 Kg	3.385 €
GAST-PAGB1300	-2 / +8	200X70X60	3	330 LT	665 W	230 V / 50 Hz	304	128 Kg	2.795 €
GAST-PAGB1300C	-2 / +8	200X70X60	3	330 LT	665 W	230 V / 50 Hz	430	128 Kg	2.650 €
GAST-PAGD1300	-10 / -22	200X70X60	3	330 LT	733 W	230 V / 50 Hz	304	128 Kg	3.555 €
GAST-PAGD1300C	-10 / -22	200X70X60	3	330 LT	733 W	230 V / 50 Hz	430	128 Kg	3.400 €
GAST-PAB1400	-2 / +8	240X60X60	4	370 LT	765 W	230 V / 50 Hz	304	168 Kg	3.470 €
GAST-PAB1400C	-2 / +8	240X60X60	4	370 LT	765 W	230 V / 50 Hz	430	168 Kg	3.295 €
GAST-PAD1400	-10 / -22	240X60X60	4	370 LT	733 W	230 V / 50 Hz	304	168 Kg	4.365 €
GAST-PAD1400C	-10 / -22	240X60X60	4	370 LT	733 W	230 V / 50 Hz	430	168 Kg	4.190 €
GAST-PAGB1400	-2 / +8	240X70X60	4	450 LT	765 W	230 V / 50 Hz	304	177 Kg	3.545 €
GAST-PAGB1400C	-2 / +8	240X70X60	4	450 LT	765 W	230 V / 50 Hz	430	177 Kg	3.370 €
GAST-PAGD1400	-10 / -22	240X70X60	4	450 LT	733 W	230 V / 50 Hz	304	177 Kg	4.380 €
GAST-PAGD1400C	-10 / -22	240X70X60	4	450 LT	733 W	230 V / 50 Hz	430	177 Kg	4.215 €

CİHAZ ALTI BUZDOLABI KISA / UNDERCOUNTER REFRIGERATORS WITH SHORT / RÉFRIGÉRATEUR SOUS LE COMPTOIR

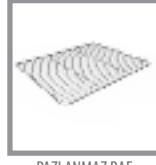
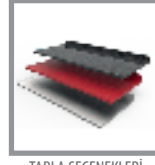
CAM KAPI
GLASS DOORÇEKMECE
DRAWERPAZLANMAZ RAF
S.S. SHELFTABLA SEÇENEKLERİ
KIND OF TOPSKİLİT
LOCKTEKERLEK
WHEEL

TR

- Dış ortam sıcaklığı +43°C %65 nem oranı
- Eşit sıcaklık dağılımı için yeni tasarım
- Sıfır ODP enjekte 42 kg/m3 çevre dostu poliüretan izolasyon
- Elektrikli otomatik defrost
- Kolay okunur ekranlı dijital kontrol
- Ergonomik kapı ve kulpu sayesinde kolay açılma ve temizlik
- Patentli 'Icecool' soğutma sistemi ile mükemmel verim ve enerji sarfıyatı
- Sıcak gaz defrost sistemi
- Atık ısı geri kazanımlı kondanzasyon
- Tüm buzdolapların marine versiyonları mevcuttur.
- Marine versiyonları 'Icecool marine' sistemi, marine ayak ve raflar içerir.

EN

- Outdoor temperature +43°C 65% humidity
- New design for even temperature distribution
- Zero ODP injected 42 kg/m3 environmentally friendly polyurethane insulation
- Electric automatic defrost
- Digital control with easy-to-read display
- Easy opening and cleaning thanks to ergonomic door and handle
- Excellent efficiency and energy consumption with patented 'Icecool' cooling system
- Hot gas defrosting system
- Condensation with waste heat recovery
- All refrigerators are available in marine versions.
- Marine versions include the 'Icecool marine' system, marine feet and shelves.

CİHAZ ALTI BUZDOLABI KISA / UNDERCOUNTER REFRIGERATORS WITH SHORT / RÉFRIGÉRATEUR SOUS LE COMPTOIR



1/2 Çekmece
1/2 Drawers

450 €



1/1 Çekmece
1/1 Drawers

345 €



Dolap Kilidi
Cabinet Lock

75 €

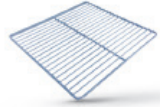

Raf ve Raf Kızağı
Shelf and Shelf Holder

55 €



Sol Motor
Left Motor

35 €



Tekerlekli
Wheels

95 €



Cam Kapı
Glass Door

240 €

Üst Tablasız Without Table Top	Kapı P.kalite Door S.S Quality	Fiyat Price
	2	304 -175 €
		430 -90 €
	3	304 -195 €
		430 -100 €
	4	304 -215 €
		430 -160 €



KOD CODE	SICAKLIK TEMP.	EBATLAR DIMENSIONS	KAPI DOOR	LİTRE LITER	GÜÇ POWER	VOLTAJ VOLTAGE	P. KALİTE S.S QLTY	KG KG	FİYAT PRICE
GAST-PAKB1200	-2 / +8	120X60X85	2	275 LT	461 W	230 V / 50 Hz	304	95 Kg	2.395 €
GAST-PAKB1200C	-2 / +8	120X60X85	2	275 LT	461 W	230 V / 50 Hz	430	95 Kg	2.295 €
GAST-PAKB1210	-2 / +8	120X70X85	2	330 LT	461 W	230 V / 50 Hz	304	100 Kg	2.420 €
GAST-PAKB1210C	-2 / +8	120X70X85	2	330 LT	461 W	230 V / 50 Hz	430	100 Kg	2.310 €
GAST-PAKB1300	-2 / +8	160X60X85	3	440 LT	665 W	230 V / 50 Hz	304	127 Kg	2.845 €
GAST-PAKB1300C	-2 / +8	160X60X85	3	440 LT	665 W	230 V / 50 Hz	430	127 Kg	2.715 €
GAST-PAKB1310	-2 / +8	160X70X85	3	515 LT	665 W	230 V / 50 Hz	304	135 Kg	2.855 €
GAST-PAKB1310C	-2 / +8	160X70X85	3	515 LT	665 W	230 V / 50 Hz	430	135 Kg	2.720 €

DİK TİP BUZDOLABI TEK KAPILI / VERTICAL REFRIGERATOR WITH 1 GLASS DOOR



Dolap Kilidi
Cabinet Lock

75 €

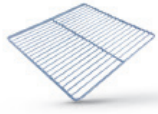

Raf ve Raf Kızağı
Shelf and Shelf Holder

55 €



Sol Kapı
Left Door

35 €



Tekerlekli
Wheels

95 €



Yarım Kapı
Half Door

225 €

TR

- Dış ortam sıcaklığı +43°C %65 nem oranı
- Eşit sıcaklık dağılımı için yeni tasarım
- Sıfır ODP enjekte 42 kg/m3 çevre dostu poliüretan izolasyon
- Elektrikli otomatik defrost
- Kolay okunur ekranlı dijital kontrol
- Ergonomik kapı ve kulpu sayesinde kolay açılma ve temizlik
- Patentli 'Icecool' soğutma sistemi ile mükemmel verim ve enerji sarfıyatı
- Sıcak gaz defrost sistemi
- Atık ısı geri kazanımlı kondanzasyon
- Tüm buzdolapların marine versiyonları mevcuttur.
- Marine versiyonları 'Icecool marine' sistemi, marine ayak ve raflar içerir.

EN

- Outdoor temperature +43°C 65% humidity
- New design for even temperature distribution
- Zero ODP injected 42 kg/m3 environmentally friendly polyurethane insulation
- Electric automatic defrost
- Digital control with easy-to-read display
- Easy opening and cleaning thanks to ergonomic door and handle
- Excellent efficiency and energy consumption with patented 'Icecool' cooling system
- Hot gas defrosting system
- Condensation with waste heat recovery
- All refrigerators are available in marine versions.
- Marine versions include the 'Icecool marine' system, marine feet and shelves.



KOD CODE	SICAKLIK TEMP.	EBATLAR DIMENSIONS	KAPI DOOR	LİTRE LITER	GÜÇ POWER	VOLTAJ VOLTAGE	P. KALİTE S.S QLTY	KG KG	FİYAT PRICE
GAST-DTB1100	-2 / +8	70X77X210	1	520 LT	461 W	230 V / 50 Hz	304	116 Kg	2.615 €
GAST-DTB1100C	-2 / +8	70X77X210	1	520 LT	461 W	230 V / 50 Hz	430	116 Kg	2.195 €
GAST-DTD1100	-10 / -22	70X77X210	1	520 LT	733 W	230 V / 50 Hz	304	116 Kg	3.130 €
GAST-DTD1100C	-10 / -22	70X77X210	1	520 LT	733 W	230 V / 50 Hz	430	116 Kg	2.750 €
GAST-DTGB1100	-2 / +8	70X87X210	1	610 LT	461 W	230 V / 50 Hz	304	124 Kg	2.595 €
GAST-DTGB1100C	-2 / +8	70X87X210	1	610 LT	461 W	230 V / 50 Hz	430	124 Kg	2.175 €
GAST-DTGD1100	-10 / -22	70X87X210	1	610 LT	733 W	230 V / 50 Hz	304	124 Kg	3.100 €
GAST-DTGD1100C	-10 / -22	70X87X210	1	610 LT	733 W	230 V / 50 Hz	430	124 Kg	2.730 €

DİK TİP BUZDOLABI TEK CAM KAPILI / VERTICAL REFRIGERATOR WITH 1 GLASS DOOR   



Dolap Kilidi
Cabinet Lock

75 €

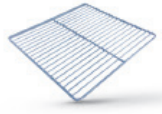

Raf ve Raf Kızağı
Shelf and Shelf Holder

55 €



Sol Kapı
Left Door

35 €



Tekerlekli
Wheels

95 €



Yarım Kapı
Half Door

225 €

TR

- Dış ortam sıcaklığı +43°C %65 nem oranı
- Eşit sıcaklık dağılımı için yeni tasarım
- Sıfır ODP enjekte 42 kg/m³ çevre dostu poliüretan izolasyon
- Elektrikli otomatik defrost
- Kolay okunur ekranlı dijital kontrol
- Ergonomik kapı ve kulpu sayesinde kolay açılma ve temizlik
- Patentli 'Icecool' soğutma sistemi ile mükemmel verim ve enerji sarfıyatı
- Sıcak gaz defrost sistemi
- Atık ısı geri kazanımlı kondenzasyon
- Tüm buzdolapların marine versiyonları mevcuttur.
- Marine versiyonları 'Icecool marine' sistemi, marine ayak ve raflar içerir.

EN

- Outdoor temperature +43°C 65% humidity
- New design for even temperature distribution
- Zero ODP injected 42 kg/m³ environmentally friendly polyurethane insulation
- Electric automatic defrost
- Digital control with easy-to-read display
- Easy opening and cleaning thanks to ergonomic door and handle
- Excellent efficiency and energy consumption with patented 'Icecool' cooling system
- Hot gas defrosting system
- Condensation with waste heat recovery
- All refrigerators are available in marine versions.
- Marine versions include the 'Icecool marine' system, marine feet and shelves.



KOD CODE	SICAKLIK TEMP.	EBATLAR DIMENSIONS	KAPI DOOR	LİTRE LITER	GÜÇ POWER	VOLTAJ VOLTAGE	P. KALİTE S.S QLTY	KG KG	FİYAT PRICE
GAST-DTCB1100	-2 / +8	70X77X210	1	520 LT	461 W	230 V / 50 Hz	304	126 Kg	3.150 €
GAST-DTB1100C	-2 / +8	70X77X210	1	520 LT	461 W	230 V / 50 Hz	430	126 Kg	2.675 €
GAST-DTCD1100	-10 / -22	70X77X210	1	520 LT	733 W	230 V / 50 Hz	304	126 Kg	3.975 €
GAST-DTCD1100C	-10 / -22	70X77X210	1	520 LT	733 W	230 V / 50 Hz	430	126 Kg	3.445 €
GAST-DTCGB1100	-2 / +8	70X87X210	1	610 LT	461 W	230 V / 50 Hz	304	133 Kg	3.135 €
GAST-DTCGB1100C	-2 / +8	70X87X210	1	610 LT	461 W	230 V / 50 Hz	430	133 Kg	2.665 €
GAST-DTCGD1100	-10 / -22	70X87X210	1	610 LT	733 W	230 V / 50 Hz	304	133 Kg	3.965 €
GAST-DTCGD1100C	-10 / -22	70X87X210	1	610 LT	733 W	230 V / 50 Hz	430	133 Kg	3.435 €

DİK TİP BUZDOLABI ÇİFT KAPILI / VERTICAL REFRIGERATOR WITH 2 GLASS DOOR



Dolap Kilidi
Cabinet Lock

75 €

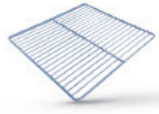

Raf ve Raf Kızağı
Shelf and Shelf Holder

55 €



Tekerlekli
Wheels

95 €



Yarım Kapı
Half Door

225 €

TR

- Dış ortam sıcaklığı +43°C %65 nem oranı
- Eşit sıcaklık dağılımı için yeni tasarım
- Sıfır ODP enjekte 42 kg/m3 çevre dostu poliüretan izolasyon
- Elektrikli otomatik defrost
- Kolay okunur ekranlı dijital kontrol
- Ergonomik kapı ve kulpu sayesinde kolay açılma ve temizlik
- Patentli 'Icecool' soğutma sistemi ile mükemmel verim ve enerji sarfıyatı
- Sıcak gaz defrost sistemi
- Atık ısı geri kazanımlı kondanzasyon
- Tüm buzdolapların marine versiyonları mevcuttur.
- Marine versiyonları 'Icecool marine' sistemi, marine ayak ve raflar içerir.

EN

- Outdoor temperature +43°C 65% humidity
- New design for even temperature distribution
- Zero ODP injected 42 kg/m3 environmentally friendly polyurethane insulation
- Electric automatic defrost
- Digital control with easy-to-read display
- Easy opening and cleaning thanks to ergonomic door and handle
- Excellent efficiency and energy consumption with patented 'Icecool' cooling system
- Hot gas defrosting system
- Condensation with waste heat recovery
- All refrigerators are available in marine versions.
- Marine versions include the 'Icecool marine' system, marine feet and shelves.



KOD CODE	SICAKLIK TEMP.	EBATLAR DIMENSIONS	KAPI DOOR	LİTRE LITER	GÜÇ POWER	VOLTAJ VOLTAGE	P. KALİTE S.S QLTY	KG KG	FİYAT PRICE
GAST-DTB1200	-2 / +8	140X77X210	2	1150 LT	1214 W	230 V / 50 Hz	304	175 Kg	3.720 €
GAST-DTB1200C	-2 / +8	140X77X210	2	1150 LT	1214 W	230 V / 50 Hz	430	175 Kg	3.050 €
GAST-DTD1200	-10 / -22	140X77X210	2	1150 LT	932 W	230 V / 50 Hz	304	175 Kg	4.560 €
GAST-DTD1200C	-10 / -22	140X77X210	2	1150 LT	932 W	230 V / 50 Hz	430	175 Kg	3.955 €
GAST-DTGB1200	-2 / +8	140X87X210	2	1340 LT	1214 W	230 V / 50 Hz	304	190 Kg	3.700 €
GAST-DTGB1200C	-2 / +8	140X87X210	2	1340 LT	1214 W	230 V / 50 Hz	430	190 Kg	3.080 €
GAST-DTGD1200	-10 / -22	140X87X210	2	1340 LT	932 W	230 V / 50 Hz	304	190 Kg	4.575 €
GAST-DTGD1200C	-10 / -22	140X87X210	2	1340 LT	932 W	230 V / 50 Hz	430	190 Kg	3.970 €

DİK TİP BUZDOLABI ÇİFT KAPILI / VERTICAL REFRIGERATOR WITH 2 GLASS DOOR



Dolap Kilidi
Cabinet Lock

75 €

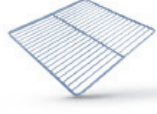

Raf ve Raf Kızağı
Shelf and Shelf Holder

55 €



Tekerlekli
Wheels

95 €



Yarım Kapı
Half Door

225 €

TR

- Dış ortam sıcaklığı +43°C %65 nem oranı
- Eşit sıcaklık dağılımı için yeni tasarım
- Sıfır ODP enjekte 42 kg/m3 çevre dostu poliüretan izolasyon- Elektrikli otomatik defrost
- Kolay okunur ekranlı dijital kontrol
- Ergonomik kapı ve kulpu sayesinde kolay açılma ve temizlik
- Patentli 'Icecool' soğutma sistemi ile mükemmel verim ve enerji sarfıyatı
- Sıcak gaz defrost sistemi
- Atık ısı geri kazanımlı kondanzasyon
- Tüm buzdolapların marine versiyonları mevcuttur.
- Marine versiyonları 'Icecool marine' sistemi, marine ayak ve raflar içerir.

EN

- Outdoor temperature +43°C 65% humidity
- New design for even temperature distribution
- Zero ODP injected 42 kg/m3 environmentally friendly polyurethane insulation
- Electric automatic defrost
- Digital control with easy-to-read display
- Easy opening and cleaning thanks to ergonomic door and handle
- Excellent efficiency and energy consumption with patented 'Icecool' cooling system
- Hot gas defrosting system
- Condensation with waste heat recovery
- All refrigerators are available in marine versions.
- Marine versions include the 'Icecool marine' system, marine feet and shelves.



KOD CODE	SICAKLIK TEMP.	EBATLAR DIMENSIONS	KAPI DOOR	LİTRE LITER	GÜÇ POWER	VOLTAJ VOLTAGE	P. KALİTE S.S QLTY	KG KG	FİYAT PRICE
GAST-DTCB1200	-2 / +8	140X77X210	2	1150 LT	1214 W	230 V / 50 Hz	304	224 Kg	4.685 €
GAST-DTCB1200C	-2 / +8	140X77X210	2	1150 LT	1214 W	230 V / 50 Hz	430	224 Kg	4.015 €
GAST-DTCD1200	-10 / -22	140X77X210	2	1150 LT	1040 W	230 V / 50 Hz	304	224 Kg	6.115 €
GAST-DTCD1200C	-10 / -22	140X77X210	2	1150 LT	1040 W	230 V / 50 Hz	430	224 Kg	5.485 €
GAST-DTCGB1200	-2 / +8	140X87X210	2	1340 LT	1214 W	230 V / 50 Hz	304	237 Kg	4.705 €
GAST-DTCGB1200C	-2 / +8	140X87X210	2	1340 LT	1214 W	230 V / 50 Hz	430	237 Kg	4.035 €
GAST-DTCGD1200	-10 / -22	140X87X210	2	1340 LT	1040 W	230 V / 50 Hz	304	237 Kg	6.130 €
GAST-DTCGD1200C	-10 / -22	140X87X210	2	1340 LT	1040 W	230 V / 50 Hz	430	237 Kg	5.500 €

MAKE UP BUZDOLAPLARI - YÜKSEK / MAKE UP REFRIGERATORS - HIGH



Gastronom küvetler
fiyata dahil değildir.
Gastronom containers
are not included.



TR

- Dış ortam sıcaklığı +43°C %65 nem oranı
- Eşit sıcaklık dağılımı için yeni tasarım
- Sıfır ODP enjekte 42 kg/m3 çevre dostu poliüretan izolasyon
- Elektrikli otomatik defrost
- Kolay okunur ekranlı dijital kontrol
- Ergonomik kapı ve kulpu sayesinde kolay açılma ve temizlik
- Patentli 'Icecool' soğutma sistemi ile mükemmel verim ve enerji sarfıyatı
- Sıcak gaz defrost sistemi
- Atık ısı geri kazanımlı kondanzasyon
- Tüm buzdolapların marine versiyonları mevcuttur.
- Marine versiyonları 'Icecool marine' sistemi, marine ayak ve raflar içerir.

EN

- Outdoor temperature +43°C 65% humidity
- New design for even temperature distribution
- Zero ODP injected 42 kg/m3 environmentally friendly polyurethane insulation
- Electric automatic defrost
- Digital control with easy-to-read display
- Easy opening and cleaning thanks to ergonomic door and handle
- Excellent efficiency and energy consumption with patented 'Icecool' cooling system
- Hot gas defrosting system
- Condensation with waste heat recovery
- All refrigerators are available in marine versions.
- Marine versions include the 'Icecool marine' system, marine feet and shelves.

MAKE UP BUZDOLAPLARI - YÜKSEK / MAKE UP REFRIGERATORS - HIGH



1/2 Çekmece
1/2 Drawers

490 €



1/3 Çekmece
1/3 Drawers

625 €



Dolap Kilidi
Cabinet Lock

75 €

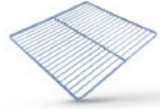

Raf ve Raf Kızağı
Shelf and Shelf Holder

55 €



Sol Motor
Left Motor

35 €



Tekerlekli
Wheels

95 €



Cam Kapı
Glass Door

240 €

Gastronom küvetler
fiyata dahil değildir.
Gastronom containers
are not included.



KOD CODE	SICAKLIK TEMP.	EBATLAR DIMENSIONS	KAPI DOOR	LİTRE LITER	GÜÇ POWER	VOLTAJ VOLTAGE	P. KALİTE S.S QLTY	KG KG	FİYAT PRICE
GAST-MUB1200	-2 / +8	150X60X85/143	2	275 LT	461 W	230 V / 50 Hz	304	116 Kg	3.160 €
GAST-MUB1200C	-2 / +8	150X60X85/143	2	275 LT	461 W	230 V / 50 Hz	430	116 Kg	2.970 €
GAST-MUGB1200	-2 / +8	150X70X85/143	2	330 LT	461 W	230 V / 50 Hz	304	123 Kg	3.300 €
GAST-MUGB1200C	-2 / +8	150X70X85/143	2	330 LT	461 W	230 V / 50 Hz	430	123 Kg	3.105 €
GAST-MPB1300	-2 / +8	200X60X85	3	440 LT	665 W	230 V / 50 Hz	304	195 Kg	3.930 €
GAST-MPB1300C	-2 / +8	200X60X85	3	440 LT	665 W	230 V / 50 Hz	430	195 Kg	3.670 €
GAST-MUGB1300	-2 / +8	200X70X85	3	515 LT	665 W	230 V / 50 Hz	304	205 Kg	4.080 €
GAST-MUGB1300C	-2 / +8	200X70X85	3	515 LT	665 W	230 V / 50 Hz	430	205 Kg	3.820 €
GAST-MUB1400	-2 / +8	250X60X85	4	560 LT	765 W	230 V / 50 Hz	304	198 Kg	4.985 €
GAST-MUB1400C	-2 / +8	250X60X85	4	560 LT	765 W	230 V / 50 Hz	430	198 Kg	4.670 €
GAST-MUGB1400	-2 / +8	250X70X85	4	650 LT	765 W	230 V / 50 Hz	304	209 Kg	4.905 €
GAST-MUGB1400C	-2 / +8	250X70X85	4	650 LT	765 W	230 V / 50 Hz	430	209 Kg	4.590 €

MAKE UP BUZDOLAPLARI - KISA / MAKE UP REFRIGERATORS - SHORT



Gastronom küvetler
fiyata dahil değildir.
Gastronom containers
are not included.



COLD UNITS

TR

- Dış ortam sıcaklığı +43°C %65 nem oranı
- Eşit sıcaklık dağılımı için yeni tasarım
- Sıfır ODP enjekte 42 kg/m³ çevre dostu poliüretan izolasyon
- Elektrikli otomatik defrost
- Kolay okunur ekranlı dijital kontrol
- Ergonomik kapı ve kulpu sayesinde kolay açılma ve temizlik
- Patentli 'Icecool' soğutma sistemi ile mükemmel verim ve enerji sarfıyatı
- Sıcak gaz defrost sistemi
- Atık ısı geri kazanımlı kondanzasyon
- Tüm buzdolapların marine versiyonları mevcuttur.
- Marine versiyonları 'Icecool marine' sistemi, marine ayak ve raflar içerir.

EN

- Outdoor temperature +43°C 65% humidity
- New design for even temperature distribution
- Zero ODP injected 42 kg/m³ environmentally friendly polyurethane insulation
- Electric automatic defrost
- Digital control with easy-to-read display
- Easy opening and cleaning thanks to ergonomic door and handle
- Excellent efficiency and energy consumption with patented 'Icecool' cooling system
- Hot gas defrosting system
- Condensation with waste heat recovery
- All refrigerators are available in marine versions.
- Marine versions include the 'Icecool marine' system, marine feet and shelves.

MAKE UP BUZDOLAPLARI - KISA / MAKE UP REFRIGERATORS - SHORT



1/2 Çekmece
1/2 Drawers

490 €



1/3 Çekmece
1/3 Drawers

625 €



Dolap Kilidi
Cabinet Lock

75 €

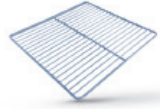

Raf ve Raf Kızağı
Shelf and Shelf Holder

55 €



Sol Motor
Left Motor

35 €



Tekerlekli
Wheels

95 €



Cam Kapı
Glass Door

240 €

Granit Üst Tabla Granite Work Top	Kapı Door	Fiyat Price
	2	780 €
	3	1.135 €
	4	1.305 €

Polietilen Üst Tabla Polyethylene Work Top	Kapı Door	Fiyat Price
	2	740 €
	3	980 €
	4	1.250 €

Gastronom küvetler
fiyata dahil değildir.
Gastronom containers
are not included.

Mermer Üst Tabla Marble Work Top	Kapı Door	Fiyat Price
	2	390 €
	3	505 €
	4	655 €

Üst Tablasız Without Table Top	Kapı Door	P.kalite S.S Quality	Fiyat Price
	2	304	-175 €
		430	-90 €
	3	304	-195 €
		430	-100 €
	4	304	-215 €
		430	-160 €



KOD CODE	SICAKLIK TEMP.	EBATLAR DIMENSIONS	KAPI DOOR	LİTRE LITER	GÜÇ POWER	VOLTAJ VOLTAGE	P. KALİTE S.S QLTY	KG KG	FİYAT PRICE
GAST-MUKB1200	-2 / +8	150X70X85	2	330 LT	461 W	230 V / 50 Hz	304	100 Kg	3.060 €
GAST-MUKB1200C	-2 / +8	150X70X85	2	330 LT	461 W	230 V / 50 Hz	430	100 Kg	2.880 €
GAST-MUKB1300	-2 / +8	200X70X85	3	515 LT	665 W	230 V / 50 Hz	304	135 Kg	3.540 €
GAST-MUKB1300C	-2 / +8	200X70X85	3	515 LT	665 W	230 V / 50 Hz	430	135 Kg	3.395 €
GAST-MUKB1400	-2 / +8	250X70X85	4	650 LT	765 W	230 V / 50 Hz	304	195 Kg	4.435 €
GAST-MUKB1400C	-2 / +8	250X70X85	4	650 LT	765 W	230 V / 50 Hz	430	195 Kg	4.245 €

MAKE UP BUZDOLAPLARI - MERMERLİ / MAKE UP REFRIGERATORS - MARBLE



Gastronom küvetler
fiyata dahil değildir.
Gastronom containers
are not included.

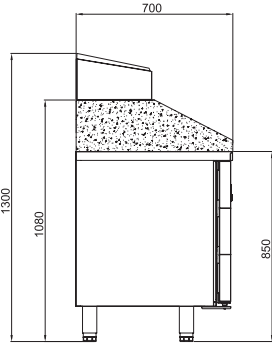
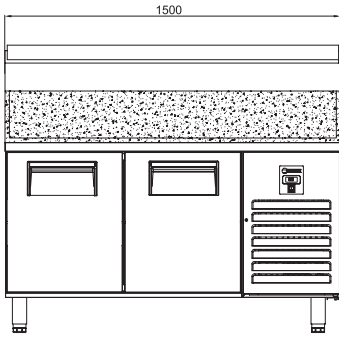

TR

- Dış ortam sıcaklığı +43°C %65 nem oranı
- Eşit sıcaklık dağılımı için yeni tasarım
- Sıfır ODP enjekte 42 kg/m3 çevre dostu poliüretan izolasyon
- Elektrikli otomatik defrost
- Kolay okunur ekranlı dijital kontrol
- Ergonomik kapı ve kulpu sayesinde kolay açılma ve temizlik
- Patentli 'Icecool' soğutma sistemi ile mükemmel verim ve enerji sarfıyatı
- Sıcak gaz defrost sistemi
- Atık ısı geri kazanımlı kondanzasyon
- Tüm buzdolapların marine versiyonları mevcuttur.
- Marine versiyonları 'Icecool marine' sistemi, marine ayak ve raflar içerir.

EN

- Outdoor temperature +43°C 65% humidity
- New design for even temperature distribution
- Zero ODP injected 42 kg/m3 environmentally friendly polyurethane insulation
- Electric automatic defrost
- Digital control with easy-to-read display
- Easy opening and cleaning thanks to ergonomic door and handle
- Excellent efficiency and energy consumption with patented 'Icecool' cooling system
- Hot gas defrosting system
- Condensation with waste heat recovery
- All refrigerators are available in marine versions.
- Marine versions include the 'Icecool marine' system, marine feet and shelves.

MAKE UP BUZDOLAPLARI - MERMERLİ / MAKE UP REFRIGERATORS - MARBLE



1/2 Çekmece
1/2 Drawers

490 €



1/3 Çekmece
1/3 Drawers

625 €



Dolap Kilidi
Cabinet Lock

75 €

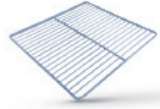

Raf ve Raf Kızağı
Shelf and Shelf Holder

55 €



Sol Motor
Left Motor

55 €



Tekerlekli
Wheels

95 €



Cam Kapı
Glass Door

240 €

Gastronom küvetler
fiyata dahil değildir.
Gastronom containers
are not included.



KOD CODE	SICAKLIK TEMP.	EBATLAR DIMENSIONS	KAPI DOOR	LİTRE LITER	GÜÇ POWER	VOLTAJ VOLTAGE	P. KALİTE S.S QLTY	KG KG	FİYAT PRICE
GAST-MMUB1200	-2 / +8	150X70X85	2	330 LT	461 W	230 V / 50 Hz	304	146 Kg	3.785 €
GAST-MMUB1200C	-2 / +8	150X70X85	2	330 LT	461 W	230 V / 50 Hz	430	146 Kg	3.600 €
GAST-MMUB1300	-2 / +8	200X70X85	3	515 LT	665 W	230 V / 50 Hz	304	247 Kg	4.535 €
GAST-MMUB1300C	-2 / +8	200X70X85	3	515 LT	665 W	230 V / 50 Hz	430	247 Kg	4.280 €
GAST-MMUB1400	-2 / +8	250X70X85	4	650 LT	765 W	230 V / 50 Hz	304	262 Kg	5.580 €
GAST-MMUB1400C	-2 / +8	250X70X85	4	650 LT	765 W	230 V / 50 Hz	430	262 Kg	5.275 €

MAKE UP BUZDOLAPLARI - MERMERLİ / MAKE UP REFRIGERATORS - MARBLE



Gastronom küvetler
fiyata dahil değildir.
Gastronom containers
are not included.

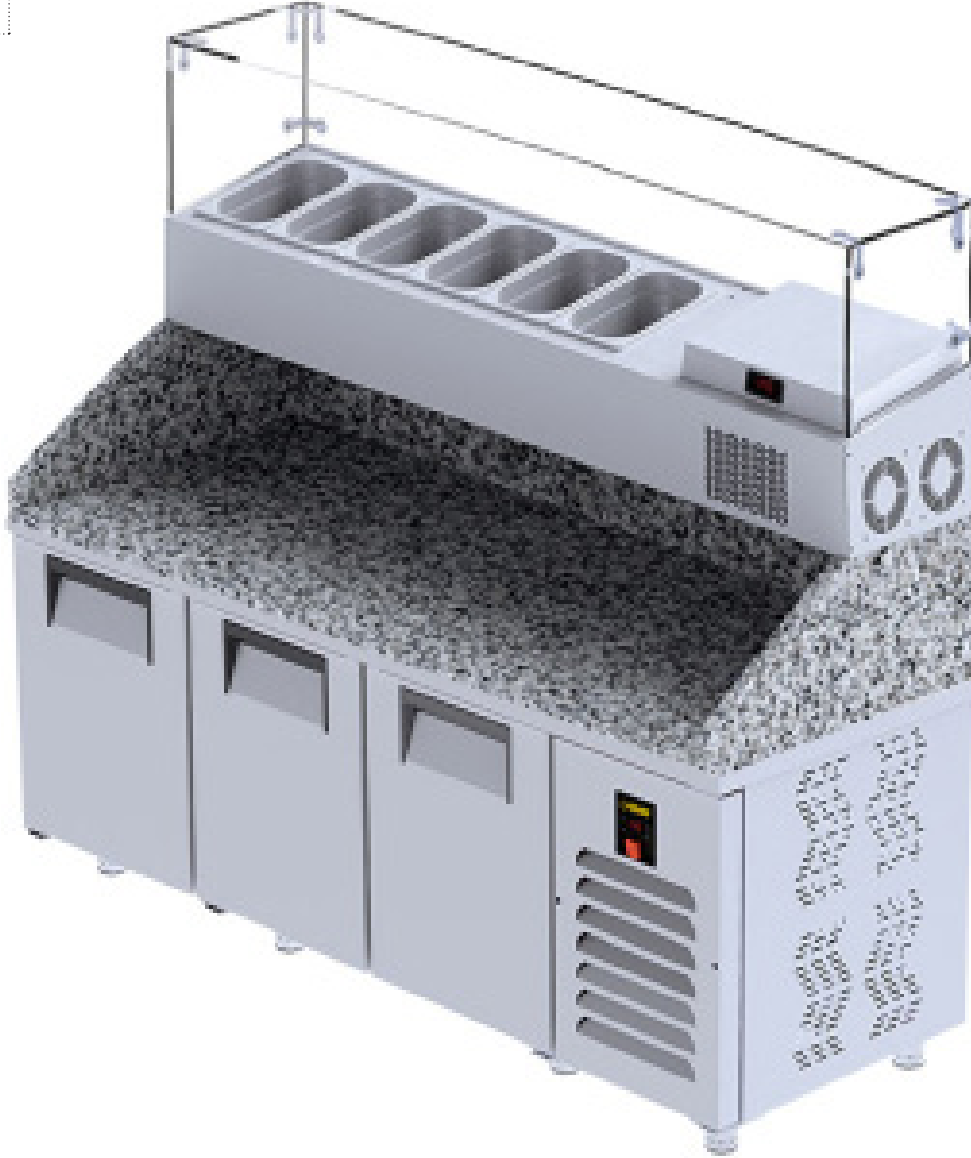

TR

- Dış ortam sıcaklığı +43°C %65 nem oranı
- Eşit sıcaklık dağılımı için yeni tasarım
- Sıfır ODP enjekte 42 kg/m3 çevre dostu poliüretan izolasyon
- Elektrikli otomatik defrost
- Kolay okunur ekranlı dijital kontrol
- Ergonomik kapı ve kulpu sayesinde kolay açılma ve temizlik
- Patentli 'Icecool' soğutma sistemi ile mükemmel verim ve enerji sarfıyatı
- Sıcak gaz defrost sistemi
- Atık ısı geri kazanımlı kondanzasyon
- Tüm buzdolapların marine versiyonları mevcuttur.
- Marine versiyonları 'Icecool marine' sistemi, marine ayak ve raflar içerir.

EN

- Outdoor temperature +43°C 65% humidity
- New design for even temperature distribution
- Zero ODP injected 42 kg/m3 environmentally friendly polyurethane insulation
- Electric automatic defrost
- Digital control with easy-to-read display
- Easy opening and cleaning thanks to ergonomic door and handle
- Excellent efficiency and energy consumption with patented 'Icecool' cooling system
- Hot gas defrosting system
- Condensation with waste heat recovery
- All refrigerators are available in marine versions.
- Marine versions include the 'Icecool marine' system, marine feet and shelves.

MAKE UP BUZDOLAPLARI 40X60 TEPŞİ KAPASİTELİ / MAKE UP REFRIGERATORS W/40X60 TRAY CAPACITY



1/2 Çekmece
1/2 Drawers

490 €



1/3 Çekmece
1/3 Drawers

625€



Dolap Kilidi
Cabinet Lock

75 €

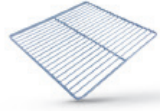

Raf ve Raf Kızağı
Shelf and Shelf Holder

55 €



Sol Motor
Left Motor

35 €



Tekerlekli
Wheels

95 €



Cam Kapı
Glass Door

240 €

Gastronom küvetler
fiyata dahil değildir.
Gastronom containers
are not included.

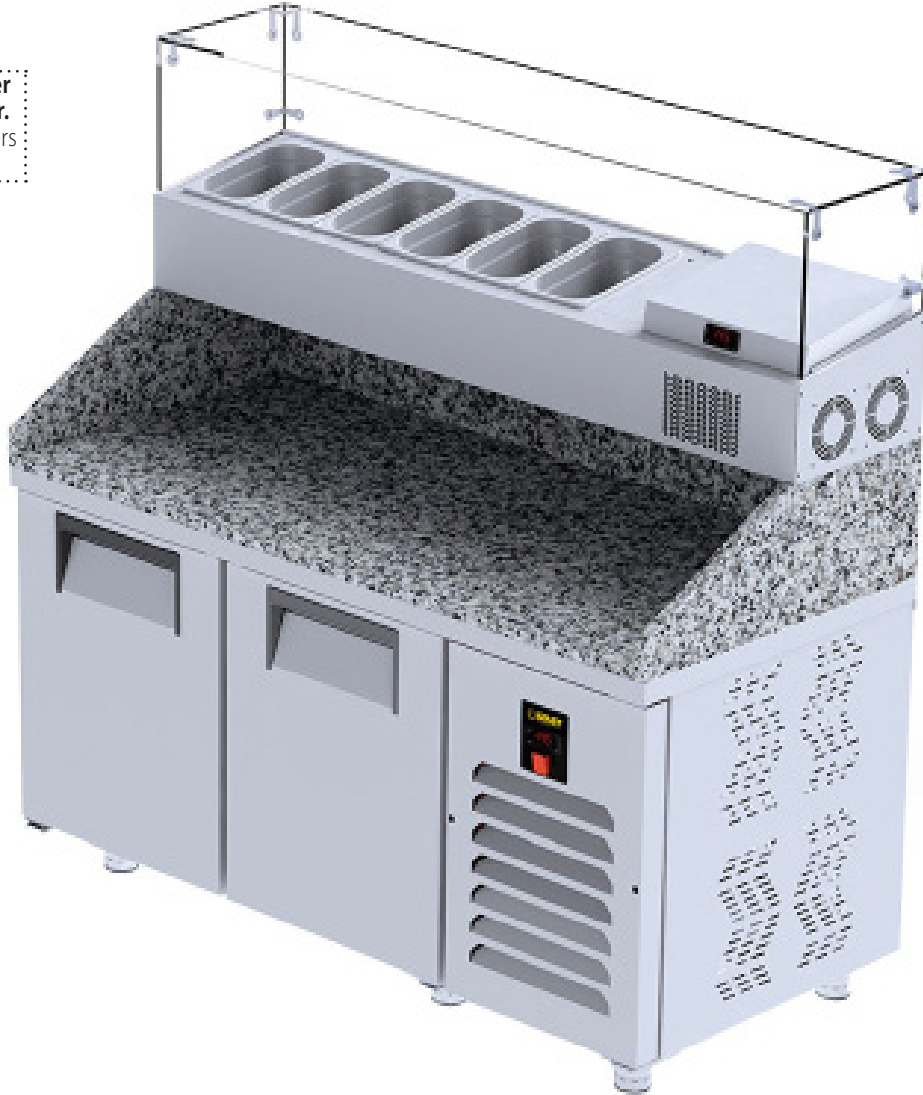

KOD CODE	SICAKLIK TEMP.	EBATLAR DIMENSIONS	KAPI DOOR	LİTRE LITER	GÜÇ POWER	VOLTAJ VOLTAGE	TÜKETİM CONSUMPTION	P. KALİTE S.S QLTY	KG KG	FİYAT PRICE
GAST-MMUB1250	-2 / +8	150X80X85	2	330 LT	461 W	230 V / 50 Hz	0,321 kW 1,93 A	304	146 Kg	3.965 €
GAST-MMUB1250C	-2 / +8	150X80X85	2	330 LT	461 W	230 V / 50 Hz	0,321 kW 1,93 A	430	146 Kg	3.540 €
GAST-MMUB1350	-2 / +8	200X80X85	3	515 LT	665 W	230 V / 50 Hz	0,336 kW 1,98 A	304	247 Kg	4.665 €
GAST-MMUB1350C	-2 / +8	200X80X85	3	515 LT	665 W	230 V / 50 Hz	0,336 kW 1,98 A	430	247 Kg	4.165 €

SET ÜSTÜ SALADBARLAR / COUNTERTOP SALADBARS

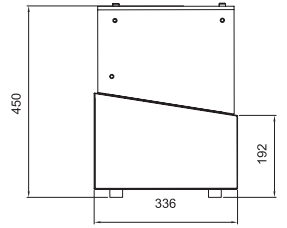
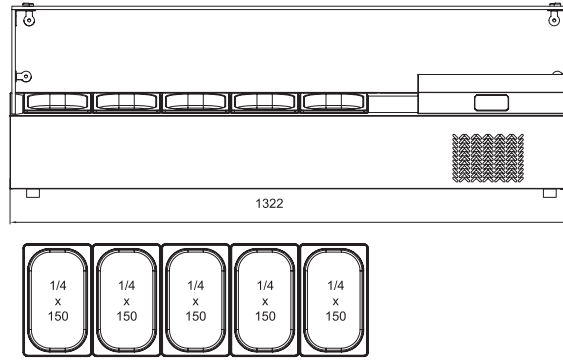
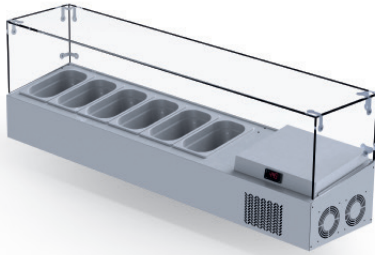
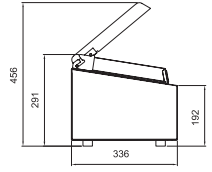
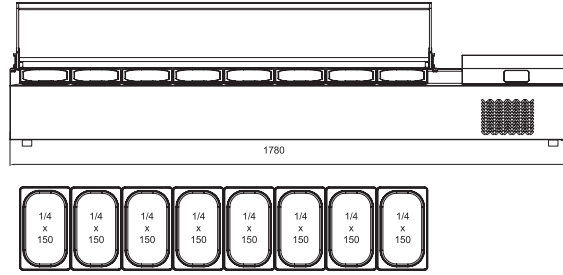

Gastronom kuvvetler
fiyata dahil değildir.
Gastronom containers
are not included.

TR

- Dış ortam sıcaklığı +43°C %65 nem oranı
- Eşit sıcaklık dağılımı için yeni tasarım
- Sıfır ODP enjekte 42 kg/m³ çevre dostu poliüretan izolasyon
- Elektrikli otomatik defrost
- Kolay okunur ekranlı dijital kontrol
- Ergonomik kapı ve kulpu sayesinde kolay açılma ve temizlik
- Patentli 'Icecool' soğutma sistemi ile mükemmel verim ve enerji sarfıyatı
- Sıcak gaz defrost sistemi
- Atık ısı geri kazanımlı kondansasyon
- Tüm buzdolapların marine versiyonları mevcuttur.
- Marine versiyonları 'Icecool marine' sistemi, marine ayak ve raflar içerir.

EN

- Outdoor temperature +43°C 65% humidity
- New design for even temperature distribution
- Zero ODP injected 42 kg/m³ environmentally friendly polyurethane insulation
- Electric automatic defrost
- Digital control with easy-to-read display
- Easy opening and cleaning thanks to ergonomic door and handle
- Excellent efficiency and energy consumption with patented 'Icecool' cooling system
- Hot gas defrosting system
- Condensation with waste heat recovery
- All refrigerators are available in marine versions.
- Marine versions include the 'Icecool marine' system, marine feet and shelves.

KOD CODE	SICAKLIK TEMP.	EBATLAR DIMENSIONS	GN 1/4-150	GÜÇ POWER	VOLTAJ VOLTAGE	TÜKETİM CONSUMPTION	KG KG	FİYAT PRICE
GAST-SBK5	+4 / +10	132X34X45	5	412 W	230 V / 50 Hz	0,2 kW 0,90 A	34 Kg	1.450 €
GAST-SBK6	+4 / +10	150X34X45	6	412 W	230 V / 50 Hz	0,2 kW 0,90	36 Kg	1.555 €
GAST-SBK8	+4 / +10	178X34X45	8	412 W	230 V / 50 Hz	0,2 kW 0,90	42 Kg	1.610 €
GAST-SBK10	+4 / +10	200X34X45	10	412 W	230 V / 50 Hz	0,2 kW 0,90	45 Kg	1.630 €
GAST-SBK11	+4 / +10	225X34X45	11	412 W	230 V / 50 Hz	0,2 kW 0,90	53 Kg	1.645 €
GAST-SBK12	+4 / +10	250X34X45	12	412 W	230 V / 50 Hz	0,2 kW 0,90	48 Kg	1.785 €
GAST-SBC5	+4 / +10	132X34X30	5	412 W	230 V / 50 Hz	0,2 kW 0,90	34 Kg	1.350 €
GAST-SBC6	+4 / +10	150X34X30	6	412 W	230 V / 50 Hz	0,2 kW 0,90	36 Kg	1.445 €
GAST-SBC8	+4 / +10	178X34X30	8	412 W	230 V / 50 Hz	0,2 kW 0,90	42 Kg	1.485 €
GAST-SBC10	+4 / +10	200X34X30	10	412 W	230 V / 50 Hz	0,2 kW 0,90	45 Kg	1.565 €
GAST-SBC11	+4 / +10	225X34X30	11	412 W	230 V / 50 Hz	0,2 kW 0,90	53 Kg	1.610 €
GAST-SBC12	+4 / +10	250X34X30	12	412 W	230 V / 50 Hz	0,2 kW 0,90	48 Kg	1.720 €

TEZGAH ALTI MİNİ BUZDOLAPLARI / CUNDERCOUNTER REFRIGERATORS

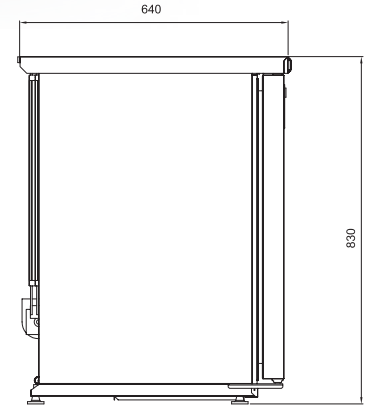
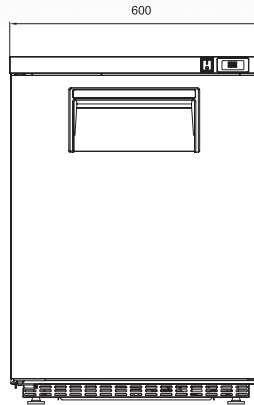

KOD CODE	SICAKLIK TEMP.	EBATLAR DIMENSIONS	KAPI DOOR	LİTRE LITER	GÜÇ POWER	VOLTAJ VOLTAGE	P. KALİTE S.S QLTY	KG KG	FİYAT PRICE
GAST-TMB1100	-2 / +8	60X64X83	1	140 LT	412 W	230 V / 50 Hz	304	62 Kg	1.585 €
GAST-TMB1100C	-2 / +8	60X64X83	1	140 LT	412 W	230 V / 50 Hz	430	62 Kg	1.495 €
GAST-TMD1100	-10 / -22	60X64X83	1	140 LT	268 W	230 V / 50 Hz	304	62 Kg	1.800 €
GAST-TMD1100C	-10 / -22	60X64X83	1	140 LT	268 W	230 V / 50 Hz	430	62 Kg	1.715 €
GAST-TCMB1100	-2 / +8	60X64X83	1 - CAM	140 LT	412 W	230 V / 50 Hz	304	62 Kg	1.875 €
GAST-TCMB1100C	-2 / +8	60X64X83	1 - CAM	140 LT	412 W	230 V / 50 Hz	430	62 Kg	1.790 €
GAST-TCMD1100	-10 / -22	60X64X83	1 - CAM	140 LT	268 W	230 V / 50 Hz	304	62 Kg	2.835 €
GAST-TCMD1100C	-10 / -22	60X64X83	1 - CAM	140 LT	268 W	230 V / 50 Hz	430	62 Kg	2.745 €

BUZ MAKİNALARI / ICE CUBE MACHINES



GAST-ICE30



GAST-ICE50



GAST-ICE90

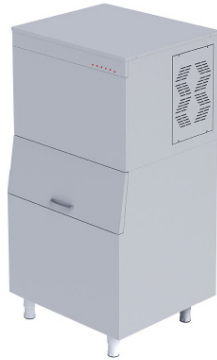

GAST-ICE250



GAST-ICE500

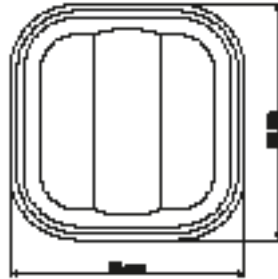
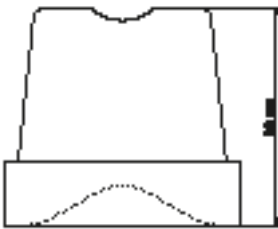
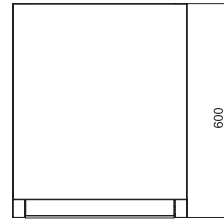
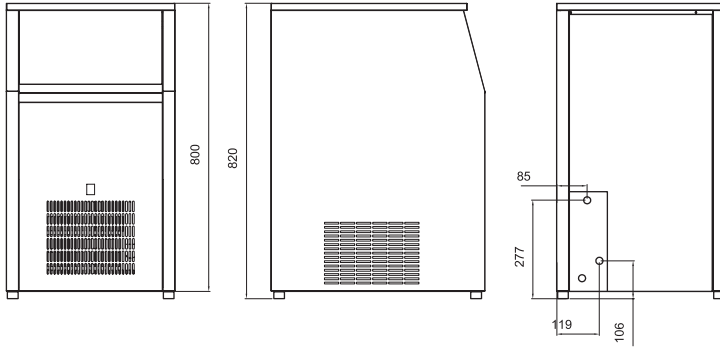

22 gr.

Daha az su tüketimi ile ayda 3 ton su tasarrufu ve daha kısa buz yapma süresi.

With less water consumption, 3 tons of water saving per month and shorter ice making time.

Yerden 28 cm yükseklikteki su gideri sayesinde ekstra pompa ihtiyacı yoktur.

There is no need for an extra water pump by the help of the 28 cm high water drain from the ground.

KOD CODE	EBATLAR DIMENSIONS	PAKET EBT PACKET DMNS	GÜNLÜK KAPASİTE DAY CAPACITY	GÜÇ POWER	VOLTAJ VOLTAGE	İKLİM SINIF TROPICAL CLASS	Soğutma Sistemi Cooling System	KG KG	FİYAT PRICE
GAST-ICE30	39 x 60 x 73	44 x 65 x 100	30 KG	540 W	230 V / 50 Hz	T	Hava (Air Cooled)	48 Kg	1.785 €
GAST-ICE50	48 x 60 x 82	53 x 65 x 110	45 KG	620 W	230 V / 50 Hz	T	Hava (Air Cooled)	56 Kg	2.225 €
GAST-ICE90	61 x 60 x 82	66 x 65 x 110	85 KG	910 W	230 V / 50 Hz	T	Hava (Air Cooled)	82 Kg	3.360 €
GAST-ICE250	82 x 72 x 60	87 x 77 x 75	250 KG	1100 W	230 V / 50 Hz	T	Hava (Air Cooled)	86 Kg	5.985 €
GAST-ICE500	82 x 72 x 83	87 x 77 x 98	500 KG	2440 W	230 V / 50 Hz	T	Hava (Air Cooled)	117 Kg	7.455 €

İÇECEK DISPANSERLERİ
BEVERAGE DISPENSERS-
Dispansaires De Boissons

İÇECEK DİSPANSERİ / BEVERAGE DISPANSERS/Dispansaires De Boissons

TR

- Kırılmaya dayanıklı polikarbon haznesi ile hijyen sağlar.
- Yeni sistem kırılmaz musluk.
- Elektromanyetik pompa/sessiz redüktör motoru.
- Paslanmaz çelik yan ve ön saçlar
- Sessiz, dayanıklı, güçlü kompresör.
- Dizaynı sayesinde kolay bakım ve temizlik sağlar
- Sarı ve paslamaz renk seçeneği.

EN

- Provides hygiene with its break-resistant polycarbonate reservoir.
- New system unbreakable faucet.
- Electromagnetic pump / silent reducer motor.
- Stainless steel side and front plates
- Silent, durable, powerful compressor.
- Easy maintenance and cleaning thanks to its design
- Yellow and rust-free colour option.

FR

- Assure l'hygiène grâce à son réservoir en polycarbonate résistant à la rupture.
- Nouveau système de robinetterie incassable.
- Pompe électromagnétique / moteur réducteur silencieux.
- Plaques latérales et frontales en acier inoxydable
- Compresseur silencieux, durable et puissant.
- Facilité d'entretien et de nettoyage grâce à son design
- Option de couleur jaune et antirouille.



GAST-ST10



GAST-ST13



GAST-ST30



GAST-ST35



GAST-ST38

KOD CODE	MODEL DESCRIPTION	LITRE LITER	KG KG	EBATLAR DIMENSIONS	GÜÇ POWER	ENERJİ ENERGY	FİYAT PRICE
GAST-ST10	Tekli Şerbet Soğutucu Single Sherbet Cooler	20 lt	20,5 Kg.	260 x 510 x 790	550 Kcal	220 V 1 ~ 50 Hz	485 €
GAST-ST12	Çiftli Şerbet+Şerbet Soğutucu Double Sherbet + Sherbet Cooler	2x20 lt	30,5 Kg.	260 x 510 x 790	720 Kcal	220 V 1 ~ 50 Hz	725 €
GAST-ST13	Çiftli Şerbet+Ayrın Soğutucu Double Sherbet + Buttermilk Cooler	2x20 lt	30,5 Kg.	440 x 485 x 750	720 Kcal	220 V 1 ~ 50 Hz	760 €
GAST-ST16	Üçlü Şerbet+Şerbet+Şerbet Soğutucu Triple Sherbet + Sherbet + Sherbet Cooler	3x20 lt	41 Kg.	660 x 485 x 750	1100 Kcal	220 V 1 ~ 50 Hz	1060 €
GAST-ST30	Royal Şerbet&Ayrın Soğutucu Royal Sherbet & Buttermilk Cooler	20 lt	22,5 Kg.	345 x 405 x 780	550 Kcal	220 V 1 ~ 50 Hz	700 €
GAST-ST34	Royal Mini Şerbet&Ayrın Soğutucu Royal Mini Sherbet & Buttermilk Cooler	11 lt	18 Kg.	270 x 375 x 740	550 Kcal	220 V 1 ~ 50 Hz	650 €
GAST-ST35	2'li Royal Şerbet&Ayrın Soğutucu 2 pcs Royal Sherbet & Ayrın Cooler	2x11 lt	25 Kg.	545 x 375 x 740	720 Kcal	220 V 1 ~ 50 Hz	980 €
GAST-ST38	3'lü Royal Şerbet&Ayrın Soğutucu 3 pcs Royal Sherbet & Ayrın Cooler	3x11 lt	32,5 Kg.	820 x 375 x 740	720 Kcal	220 V 1 ~ 50 Hz	1.320 €

ÇAY MAKİNELERİ
TEA MACHINES
Machines A Thes

ÇAY OCAKLARI / TEA KITCHENS / Cuisines A Thes

TR

- Paslanmaz Çelikten veya Bakırdan Üretilmiştir.
- Yeni sistem kırılmaz musluk.
- Çay lezzetinin uzun süre bozulmamasını sağlar.
- Hijyenik ve dayanıklıdır.
- Otomatik ısı kontrol sistemi.
- Dizaynı sayesinde kolay bakım ve temizlik sağlar.
- Toplu tüketim için uygundur.



GAST-APK02

EN

- Made of Stainless Steel or Copper.
- New system unbreakable tap.
- It ensures that the tea flavour does not deteriorate for a long time.
- Hygienic and durable.
- Automatic temperature control system.
- Easy maintenance and cleaning thanks to its design.
- Suitable for mass consumption.



GAST-BPE2

FR

- Fabriqué en acier inoxydable ou en cuivre.
- Nouveau système de robinet incassable.
- Il garantit que l'arôme du thé ne se détériore pas pendant longtemps.
- Hygiénique et durable.
- Système de contrôle automatique de la température.
- Facile à entretenir et à nettoyer grâce à sa conception.
- Convient à la consommation de masse.



GAST-EBE2

KOD CODE	MODEL DESCRIPTION	LITRE LITER	KG KG	DEMLİK TEAPOT	GÜÇ POWER	ENERJİ ENERGY	FİYAT PRICE
GAST-APK02	2 Delimli Elektrikli & Gazlı Otomatik Çay Kazanı 2 Delimlik Electric & Gas Automatic Tea Boiler	20 lt	22 Kg.	2	2500 W	220 V 1 ~ 50 Hz	1.025 €
GAST-APK03	3 Delimli Elektrikli & Gazlı Otomatik Çay Kazanı 3 Delimlik Electric & Gas Automatic Tea Boiler	30 lt	26 Kg.	3	2500 W	220 V 1 ~ 50 Hz	1.100 €
GAST-APK04	4 Delimli Elektrikli & Gazlı Otomatik Çay Kazanı 4 Delimlik Electric & Gas Automatic Tea Boiler	40 lt	34 Kg.	4	2500 W	220 V 1 ~ 50 Hz	1.420 €
GAST-BPE2	2'li Elektrikli Pro Çay Ocağı 2-Piece Electric Pro Tea Cooker	20 lt	19 Kg.	2	2500 W	220 V 1 ~ 50 Hz	820 €
GAST-BPE3	3'lü Elektrikli Pro Çay Ocağı 3-Piece Electric Pro Tea Cooker	30 lt	22 Kg.	3	2500 W	220 V 1 ~ 50 Hz	900 €
GAST-BPE4	4'lü Elektrikli Pro Çay Ocağı 4-Piece Electric Pro Tea Cooker	40 lt	27 Kg.	4	2500 W	220 V 1 ~ 50 Hz	1.100 €
GAST-EBE2	2'li Elektrikli Bakır Çay Ocağı 2-Piece Electric Copper Tea Cooker	23 lt	25 Kg.	2	2500 W	220 V 1 ~ 50 Hz	630 €
GAST-EBE3	3'lü Elektrikli Bakır Çay Ocağı 3 Piece Electric Copper Tea Cooker	32 lt	20 Kg.	3	2500 W	220 V 1 ~ 50 Hz	710 €

HAZIRLIK EKİPMANLARI
PREPARATION EQUIPMENTS
Equipement De Préparation



KIYMA MAKİNELERİ / MINCING MACHINES/Machines A Broyer

TR

- Sfero döküm kafa, helezon, kafa bileziği.
- Kolay sökülebilir ve temizlenebilir.
- Paslanmaz çelik gövde sacı ve et haznesi.
- İleri-geri çalışma sistemi.
- Soğutma sistemli.
- Plastik plastik et tokmağı.

EN

- Ductile iron head, auger, head ring.
- Easy to disassemble and clean.
- Stainless steel body plate and meat chamber.
- Forward-reverse working system.
- Cooling system.
- Plastic plastic meat rammer.

FR

- Tête, vis sans fin et anneau de tête en fonte ductile.
- Facile à démonter et à nettoyer.
- Plaque de corps et chambre à viande en acier inoxydable.
- Système de travail avant-arrière.
- Système de refroidissement.
- Pilon à viande en plastique.



GAST-KN12



GAST-KSNO22

KOD CODE	MODEL DESCRIPTION	HIZ SPEED	KG KG	EBATLAR DIMENSIONS	GÜÇ POWER	ENERJİ ENERGY	FİYAT PRICE
GAST-KN12	NO:12 Et Kıyma Makinesi NO:12 Meat Grinder	160	30 Kg.	270 x 610 x 320	0,55	220 V 1 ~ 50 Hz	1.275 €
GAST-KNO22	NO:22 Et Kıyma Makinesi NO:22 Meat Grinder	225	60 Kg.	290 x 740 x 400	1,5	220 V 1 ~ 50 Hz	1.700 €
GAST-KNO32	NO:32 Et Kıyma Makinesi NO:32 Meat Grinder	217	85 Kg.	320 x 900 x 410	2,2	220 V 1 ~ 50 Hz	1.865 €
GAST-KPNO12	NO:12 Paslanmaz Et Kıyma Makinesi NO:12 Stainless Meat Grinder	160	34 Kg.	270 x 610 x 320	0,55	220 V 1 ~ 50 Hz	1.630 €
GAST-KPNO22	NO:22 Paslanmaz Et Kıyma Makinesi NO:22 Stainless Meat Grinder	225	60 Kg.	290 x 740 x 400	1,5	220 V 1 ~ 50 Hz	2.410 €
GAST-KPNO32	NO:32 Paslanmaz Et Kıyma Makinesi NO:32 Stainless Meat Grinder	217	82 Kg.	320 x 870 x 410	2,2	220 V 1 ~ 50 Hz	2.760 €
GAST-KSNO22	NO:22 Soğutuculu Et Kıyma Makinesi NO:22 Meat Mincer with Cooler	225	75 Kg.	320 x 790 x 460	1,5	220 V 1 ~ 50 Hz	2.550 €
GAST-KSNO32	NO:32 Soğutuculu Et Kıyma Makinesi NO:32 Meat Mincer with Cooler	217	98 Kg.	360 x 880 x 480	2,2	220 V 1 ~ 50 Hz	2.940 €

ET & KEMİK TESTERELERİ

MEAT & BONE SAWS /Scie à viande et à os

ET & KEMİK TESTERESİ / MEAT & BONE SAW /Scie à viande et à os

TR

- Paslanmaz çelikten üretilmiştir.
- Soğutulmuş et ve kemik kesimi için uygundur.
- Hijyenik ve dayanıklıdır.
- Otomatik ısı kontrol sistemi.
- Dizaynı sayesinde kolay bakım ve temizlik sağlar.

EN

- Made of stainless steel.
- Suitable for chilled meat and bone cutting.
- Hygienic and durable.
- Automatic temperature control system.
- Easy maintenance and cleaning thanks to its design.

FR

- Fabriqué en acier inoxydable.
- Convient à la découpe de viandes et d'os réfrigérés.
- Hygiénique et durable.
- Système de contrôle automatique de la température.
- Facile à entretenir et à nettoyer grâce à sa conception.



GAST-KET01



GAST-KET02

KOD CODE	MODEL DESCRIPTION	EBATLAR DIMENSIONS	KG KG	GÜÇ POWER	ENERJİ ENERGY	FİYAT PRICE
GAST-KET01	Et Kemik Testeresi Paslanmaz Meat Bone Saw Stainless Steel	360 x 550 x 920	55 Kg.	1,5 kW	230 V ~ 50 Hz	3.010 €
GAST-KET02	Et Kemik Testeresi Boyalı Painted Meat Bone Saw	360 x 550 x 920	55 Kg.	1,5 kW	230 V ~ 50 Hz	1.950 €

SOĞAN DOĞRAMA

ONION CHOPPING / *Hacher Des Oignons*

SOĞAN DOĞRAMA / ONION CHOPPING / *Hacher Des Oignons*

TR

- Paslanmaz çelikten veya bakırdan üretilmiştir.
- Keskin bıçakları sayesinde ince kesim.
- Hijyenik ve dayanıklıdır.
- Dizaynı sayesinde kolay bakım ve temizlik sağlar.
- Sökülüp takılabilen paslanmaz parçalar



GAST-SOD01

EN

- Made of stainless steel or copper.
- Fine cutting with sharp blades.
- Hygienic and durable.
- Easy maintenance and cleaning thanks to its design.
- Removable stainless parts

FR

- Fabriqué en acier inoxydable ou en cuivre.
- Coupe fine grâce à ses lames tranchantes.
- Hygiénique et durable.
- Entretien et nettoyage faciles grâce à sa conception.
- Pièces amovibles en acier inoxydable



GAST-SOD02

KOD CODE	MODEL DESCRIPTION	EBATLAR DIMENSIONS	KG KG	GÜÇ POWER	ENERJİ ENERGY	FİYAT PRICE
GAST-SOD01	Soğan Doğrama Makinesi Onion Chopping Machine	250 x 300 x 520	13 Kg.	0,5 kW	220 V ~ 50 Hz	640 €
GAST-ESD02	Et Sebze Doğrama Makinesi Painted Meat Bone Saw	490 x 660 x 400	40 Kg.	2,2 kW	220 V ~ 50 Hz	2.410 €



BULAŞIK MAKİNELERİ
DISHWASHERS
Lave-Verre

BARDAK YIKAMA MAKİNESİ / GLASS WASHER / LAVEUSE EN VERRE



TR

- Paslanmaz çelik gövde ve şase
- Yüksek kalitede paslanmaz çelik ısıtıcılar
- Aynı anda devrede olmayan ısıtma sistemi ile enerji tasarrufu
- Çift cidarlı kapak
- Dönen alt ve üst yıkama kolları
- Kapağın kapatılmasıyla başlayan yıkama döngüsü
- Otomatik dolan yıkama tankı
- Emniyet termostadı
- Manyetik kapak sivici
- Kullanıcı dostu kumanda arayüzü
- Yüksekliği ayarlanabilir ayaklar
- Parlaticı pompası dahildir
- Drenaj ve deterjan pompası bağlanabilme imkanı (opsiyonel)



GAST-BY535E

EN

- Stainless steel construction
- High quality stainless steel heaters
- Not simultaneously activated heating system provides energy saving
- Double walled door
- Rotating upper and lower washing arms
- Cycle start at door closing
- Automatic tank loading
- Safety thermostat
- Magnetic door switch
- User-friendly command interface
- Height adjustable feet
- Rinse aid pump included
- Drain and detergent pump can be connected to chassis (optional)



GAST-BY640

FR

- Construction en acier inoxydable
- Chauffage en acier inoxydable de haute qualité
- Le système de chauffage non simultané permet d'économiser de l'énergie
- Porte à double paroi
- Bras de lavage supérieur et inférieur rotatifs
- Démarrage du cycle à la fermeture de la porte
- Chargement automatique de la cuve
- Thermostat de sécurité
- Interrupteur magnétique de porte
- Interface de commande conviviale
- Pieds réglables en hauteur
- Pompe de rinçage incluse
- La pompe de vidange et de détergent peut être raccordée au châssis (en option)

Drenaj pompası
Drainage Pump

Parlaticı pompası
Rinse Pump

Deterjan pompası
Detergent Pump



KOD CODE	MODEL DESCRIPTION	EBATLAR DIMENSIONS	KG KG	GÜÇ POWER	ENERJİ ENERGY	FİYAT PRICE
GAST-BY535E	Eco 500 Bardak Yıkama Makinesi Eco 500 Glass Washing Machine	440 x 500 x 680	39 Kg.	3,3 kW	220 V 1 ~ 50 Hz	1.855 €
GAST-BY640E	Eco 600 Bardak Yıkama Makinesi Eco 600 Glass Washing Machine	490 x 570 x 780	50 Kg.	3,8 kW	220 V 1 ~ 50 Hz	1.970 €
GAST-BY535	500 Bardak Yıkama Makinesi 600 Glass Washing Machine	440 x 500 x 680	39 Kg.	3,3 kW	220 V 1 ~ 50 Hz	1.990 €
GAST-BY640	600 Bardak Yıkama Makinesi 600 Glass Washing Machine	490 x 570 x 780	50 Kg.	3,8 kW	220 V 1 ~ 50 Hz	2.105 €

SET ALTI BULAŞIK YIKAMA MAKİNESİ / UNDER SET DISH WASHING MACHINE / LAVE-LINGE DISG SOUS



TR

- Paslanmaz çelik gövde ve şase
- Yüksek kalitede paslanmaz çelik ısıtıcılar
- Aynı anda devrede olmayan ısıtma sistemi ile enerji tasarrufu
- Çift cidarlı kapak
- Dönen alt ve üst yıkama kolları
- Kapağın kapatılmasıyla başlayan yıkama döngüsü
- Otomatik dolan yıkama tankı
- Emniyet termostadı
- Manyetik kapak svici
- Kullanıcı dostu kumanda arayüzü
- Yüksekliği ayarlanabilir ayaklar
- Parlaticı pompası dahildir
- Drenaj ve deterjan pompası bağlanabilme imkanı (opsiyonel)

EN

- Stainless steel construction
- High quality stainless steel heaters
- Not simultaneously activated heating system provides energy saving
- Double walled door
- Rotating upper and lower washing arms
- Cycle start at door closing
- Automatic tank loading
- Safety thermostat
- Magnetic door switch
- User-friendly command interface
- Height adjustable feet
- Rinse aid pump included
- Drain and detergent pump can be connected to chassis (optional)

FR

- Construction en acier inoxydable
- Chauffage en acier inoxydable de haute qualité
- Le système de chauffage non simultané permet d'économiser de l'énergie
- Porte à double paroi
- Bras de lavage supérieur et inférieur rotatifs
- Démarrage du cycle à la fermeture de la porte
- Chargement automatique de la cuve
- Thermostat de sécurité
- Interrupteur magnétique de porte
- Interface de commande conviviale
- Pieds réglables en hauteur
- Pompe de rinçage incluse
- La pompe de vidange et de détergent peut être raccordée au châssis (en option)



GAST-TY500

Drenaj pompası
Drainage Pump



Parlaticı pompası
Rinse Pump



Deterjan pompası
Detergent Pump



KOD CODE	MODEL DESCRIPTION	EBATLAR DIMENSIONS	KG KG	GÜÇ POWER	ENERJİ ENERGY	FİYAT PRICE
GAST-TY500E	500 Tabak Bulaşık Makinesi Dishwasher 500 Plates / Hour	590 x 670 x 820	60 Kg.	4 kW	220 V 1 ~ 50 Hz	2.175 €
GAST-TY500	500 Tabak Bulaşık Makinesi Dishwasher 500 Plates / Hour	590 x 670 x 820	60 Kg.	4 kW	220 V 1 ~ 50 Hz	2.355 €

KONVEYORLU BULAŞIK YIKAMA MAKİNESİ/ CONVEYOR DISH WASHING



TR

- 18/10 304 AISI paslanmaz çelik gövde ve şase
- Yüksek kalitede paslanmaz çelik ısıtıcılar
- Kapağın kapatılmasıyla başlayan yıkama işlemi
- Dijital sıcaklık göstergeleri (opsiyonel)
- Çift hız kademeli konveyör sistem (opsiyonel)
- Avrupa üretimi motorlar
- Soğuk su ve sıcak su bağlantı imkanı
- Sıcak su bağlantısına dayanıklı komponentler sayesinde düşük elektrik tüketimi imkanı
- Bağımsız ön yıkama ve yıkama tankı
- Ön ısıtmalı boylar tank sistemi
- Emniyet termostatları
- Kullanıcı dostu kumanda arayüzü
- Yüksekliği ayarlanabilir ayaklar
- Güvenlik için acil durdurma butonu
- Ön yıkama, yıkama, durulama ve kurutma aşamaları
- Entegre tank filtresi



GAST-KT2000

EN

- 18/10 AISI 304 stainless steel construction
- High quality stainless steel heaters
- Cycle start at door closing
- Digital temperature display (optional)
- Conveyor system with dual-stage speed (optional)
- Motors are made in Europe
- Cold water and hot water connection possibility
- Low electricity consumption thanks to components resistant to hot water connection
- Individual pre-wash and wash tank
- Pre-heated boiler tank system
- Safety switches
- User-friendly control interface
- Height-adjustable legs
- Emergency stop button for safety
- Prewashing, washing, rinsing and drying stages
- Rinsing boost, detergent and rinse aid pump can be connected to chasis (optional)

FR

- Construction en acier inoxydable 18/10 AISI 304
- Chauffage en acier inoxydable de haute qualité
- Démarrage du cycle à la fermeture de la porte
- Affichage numérique de la température (en option)
- Système de convoyage à double vitesse (en option)
- Les moteurs sont fabriqués en Europe
- Possibilité de raccordement à l'eau froide et à l'eau chaude
- Faible consommation d'électricité grâce à des composants résistants au raccordement à l'eau chaude
- Réservoir de pré-lavage et de lavage individuel
- Système de réservoir de chaudière préchauffé
- Interrupteurs de sécurité
- Interface de commande conviviale
- Pieds réglables en hauteur
- Bouton d'arrêt d'urgence pour la sécurité
- Étapes de pré-lavage, de lavage, de rinçage et de séchage



Parlatıcı pompası
Rinse Pump



Deterjan pompası
Detergent Pump



KOD CODE	MODEL DESCRIPTION	EBATLAR DIMENSIONS	KG KG	GÜÇ POWER	ENERJİ ENERGY	FİYAT PRICE
GAST-KT2000	2000 Tabak Konveyörlü Bulaşık Makinesi 2000 Plate Conveyor Dishwasher	485 x 510 x 760	45 Kg.	5,1 kW	230 V ~ 50 Hz	12.230 €
GAST-KT3000	3000 Tabak Konveyörlü Bulaşık Makinesi 3000 Plate Conveyor Dishwasher	628 x 600 x 836	55 Kg.	6 kW	230 V ~ 50 Hz	13.200 €
GAST-KT4500	4500 Tabak Konveyörlü Bulaşık Makinesi 4500 Plate Conveyor Dishwasher	628 x 600 x 836	55 Kg.	6 kW	230 V ~ 50 Hz	20.115 €

TR

- Estetik tasarım
- Paslanmaz çelikten imal edilmiş gövde
- Kolay kullanım kontrol paneli
- Özel kapak ve yay tasarımı
- 9kW boiler rezistansı ile hijyenik yıkama için 82°C'ye sabitlenmiş durulama suyu
- Her yıkamada 3litre su tüketimi
- En iyi yıkama için özel tasarlanmış yıkama ve durulama kolu
- Özel alaşımli plastik parçalar
- 3 programlı
- Kısa 60sn
- Orta 90sn
- Uzun 120sn

EN

- Esthetic design
- Stainless Steel body
- Easy usage control panel
- 3 liter water consumption for every washing
- Special designed wash and rinse spraying arm, provides the best washing
- Best washing performance with custom designed waste water discharge system
- Standard drain pump
- Low cost spare parts
- 3 programme (60sec/90sec/120sec)
- 9kw boiler heaters provides the fixed 82°C water temperature level for the best washing results.

FR

- Design esthétique
- Corps en acier inoxydable
- Panneau de contrôle d'utilisation facile
- 3 litres de consommation d'eau pour chaque lavage
- Bras de pulvérisation spécialement conçu pour le lavage et le rinçage, procurant le meilleur lavage
- Meilleure performance de lavage avec un système d'évacuation des eaux usées conçu sur mesure
- Pompe de vidange standard
- Pièces de rechange à faible coût
- 3 programmes (60sec / 90sec / 120sec)
- La résistance de la chaudière de 9 kW fournit le niveau de température d'eau fixe de 82°C pour le meilleur résultats de lavage



GAST-TBM1000

Drenaj pompası
Drainage Pump

Parlatıcı pompası
Rinse Pump

Deterjan pompası
Detergent Pump



KOD CODE	MODEL DESCRIPTION	EBATLAR DIMENSIONS	KG KG	GÜÇ POWER	ENERJİ ENERGY	FİYAT PRICE
GAST-GT1000E	1000 Tabak Giyotin Tip Bulaşık Yıkama Makinesi 1000 Plate Guillotine Type Dish Washing Machine	660 x 810 x 1390-1800	87 Kg.	9,65 kW	380 V 3 ~ 50 Hz	2.880 €
GAST-GT1000	1000 Tabak Giyotin Tip Bulaşık Yıkama Makinesi 1000 Plate Guillotine Type Dish Washing Machine	660 x 810 x 1390-1800	87 Kg.	9,65 kW	380 V 3 ~ 50 Hz	3.270 €

TEZGAHLAR
BENCHES
Comptoirs

DEMONTE ÇALIŞMA TEZGAHLARI / DISMOUNTABLE WORK TABLES / TABLE INOX AVEC DOSSERET

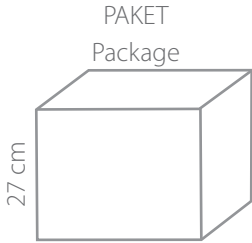

600 mm Demonte Çalışma Tezgahı

600 mm Dismountable Working Tables

KOD CODE	EBATLAR DIMENSIONS	KG KG	FİYAT PRICE
GAST-6DT06	600 x 600 x 850	21 Kg.	310 €
GAST-6DT07	700 x 600 x 850	24 Kg.	320 €
GAST-6DT08	800 x 600 x 850	25 Kg.	335 €
GAST-6DT09	900 x 600 x 850	27 Kg.	350 €
GAST-6DT10	1000 x 600 x 850	30 Kg.	355 €
GAST-6DT11	1100 x 600 x 850	32 Kg.	370 €
GAST-6DT12	1200 x 600 x 850	34 Kg.	380 €
GAST-6DT13	1300 x 600 x 850	36 Kg.	400 €
GAST-6DT14	1400 x 600 x 850	38 Kg.	420 €
GAST-6DT15	1500 x 600 x 850	40 Kg.	430 €
GAST-6DT16	1600 x 600 x 850	42 Kg.	450 €
GAST-6DT17	1700 x 600 x 850	44 Kg.	465 €
GAST-6DT18	1800 x 600 x 850	46 Kg.	475 €
GAST-6DT19	1900 x 600 x 850	48 Kg.	500 €
GAST-6DT20	2000 x 600 x 850	50 Kg.	515 €

700 mm Demonte Çalışma Tezgahı

700 mm Dismountable Working Tables

KOD CODE	EBATLAR DIMENSIONS	KG KG	FİYAT PRICE
GAST-7DT06	600 x 700 x 850	23 Kg.	315 €
GAST-7DT07	700 x 700 x 850	27 Kg.	335 €
GAST-7DT08	800 x 700 x 850	30 Kg.	345 €
GAST-7DT09	900 x 700 x 850	31 Kg.	360 €
GAST-7DT10	1000 x 700 x 850	32 Kg.	375 €
GAST-7DT11	1100 x 700 x 850	36 Kg.	395 €
GAST-7DT12	1200 x 700 x 850	38 Kg.	415 €
GAST-7DT13	1300 x 700 x 850	40 Kg.	430 €
GAST-7DT14	1400 x 700 x 850	42 Kg.	455 €
GAST-7DT15	1500 x 700 x 850	45 Kg.	480 €
GAST-7DT16	1600 x 700 x 850	47 Kg.	500 €
GAST-7DT17	1700 x 700 x 850	53 Kg.	520 €
GAST-7DT18	1800 x 700 x 850	55 Kg.	535 €
GAST-7DT19	1900 x 700 x 850	59 Kg.	550 €
GAST-7DT20	2000 x 700 x 850	62 Kg.	560 €

DEMONTTE TEK EVYELİ TEZGAH / DISMOUNTABLE WORK TABLE WITH 1 SINK / PLONGE 1 BAC AVEC ÉTAGÈRE

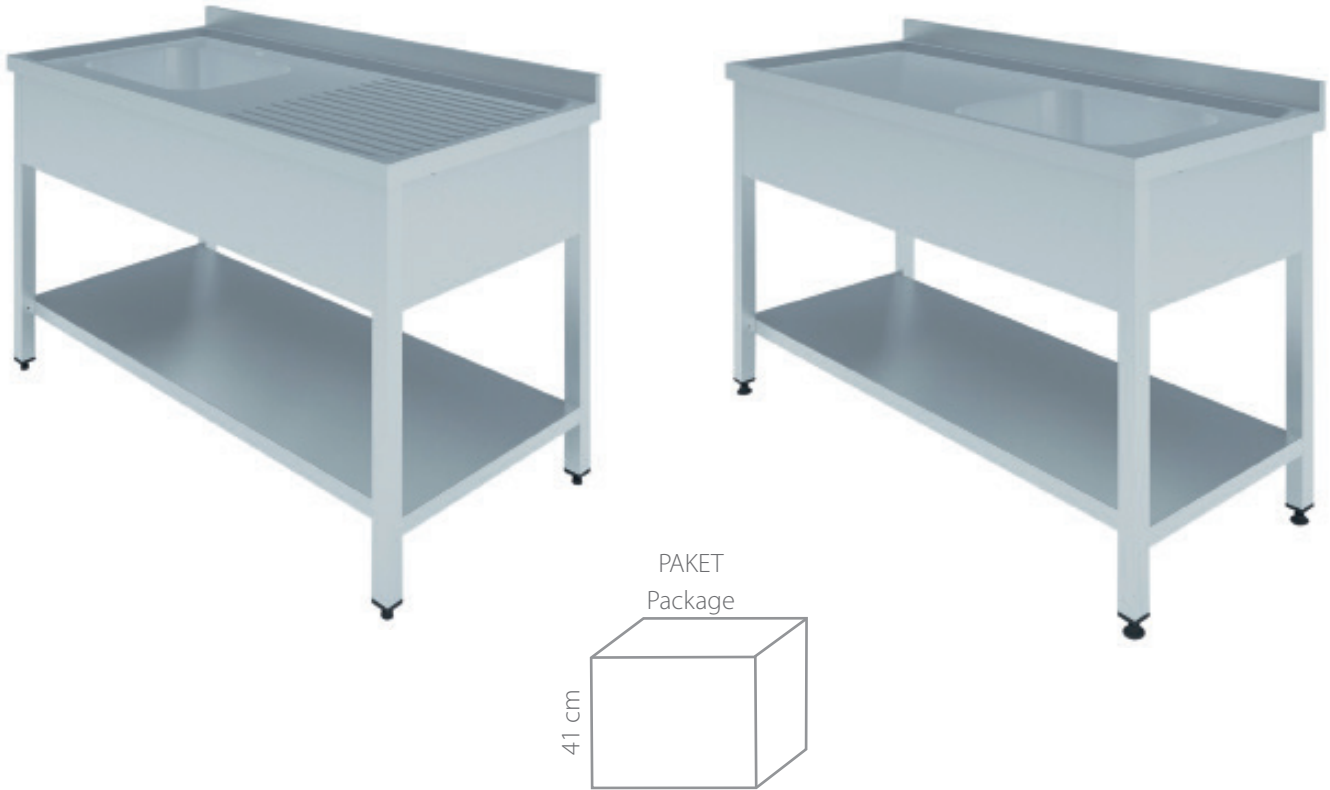

600 mm Demonte Tek Evelyi TezgaH Sol

600 mm Dismountable Work Table With 1 Sink Left

KOD CODE	EBATLAR DIMENSIONS	KG KG	FİYAT PRICE
GAST-6EDT07L	700 x 600 x 850	22 Kg.	420 €
GAST-6EDT10R	1000 x 600 x 850	24 Kg.	515 €
GAST-6EDT12R	1200 x 600 x 850	28 Kg.	570 €
GAST-6EDT14R	1400 x 600 x 850	32 Kg.	610 €

700 mm Demonte Tek Evelyi TezgaH Sol

700 mm Dismountable Work Table With 1 Sink Left

KOD CODE	EBATLAR DIMENSIONS	KG KG	FİYAT PRICE
GAST-7EDT07L	700 x 700 x 850	22 Kg.	495 €
GAST-7EDT10L	1000 x 700 x 850	24 Kg.	530 €
GAST-7EDT12L	1200 x 700 x 850	28 Kg.	590 €
GAST-7EDT14L	1400 x 700 x 850	32 Kg.	620 €

600 mm Demonte Tek Evelyi TezgaH Sağ

600 mm Dismountable Work Table With 1 Sink Right

KOD CODE	EBATLAR DIMENSIONS	KG KG	FİYAT PRICE
GAST-6EDT10R	1000 x 600 x 850	24 Kg.	515 €
GAST-6EDT12R	1200 x 600 x 850	28 Kg.	570 €
GAST-6EDT14R	1400 x 600 x 850	32 Kg.	610 €

700 mm Demonte Tek Evelyi TezgaH Sağ

700 mm Dismountable Work Table With 1 Sink Right

KOD CODE	EBATLAR DIMENSIONS	KG KG	FİYAT PRICE
GAST-6EDT10R	1000 x 700 x 850	24 Kg.	530 €
GAST-6EDT12R	1200 x 700 x 850	28 Kg.	590 €
GAST-6EDT14R	1400 x 700 x 850	32 Kg.	620 €

DEMONTE İKİ EVYELİ TEZGAH / DISMOUNTABLE WORK TABLE WITH 2 SINKS / PLONGE 2 BACS AVEC ÉTAGÈRE

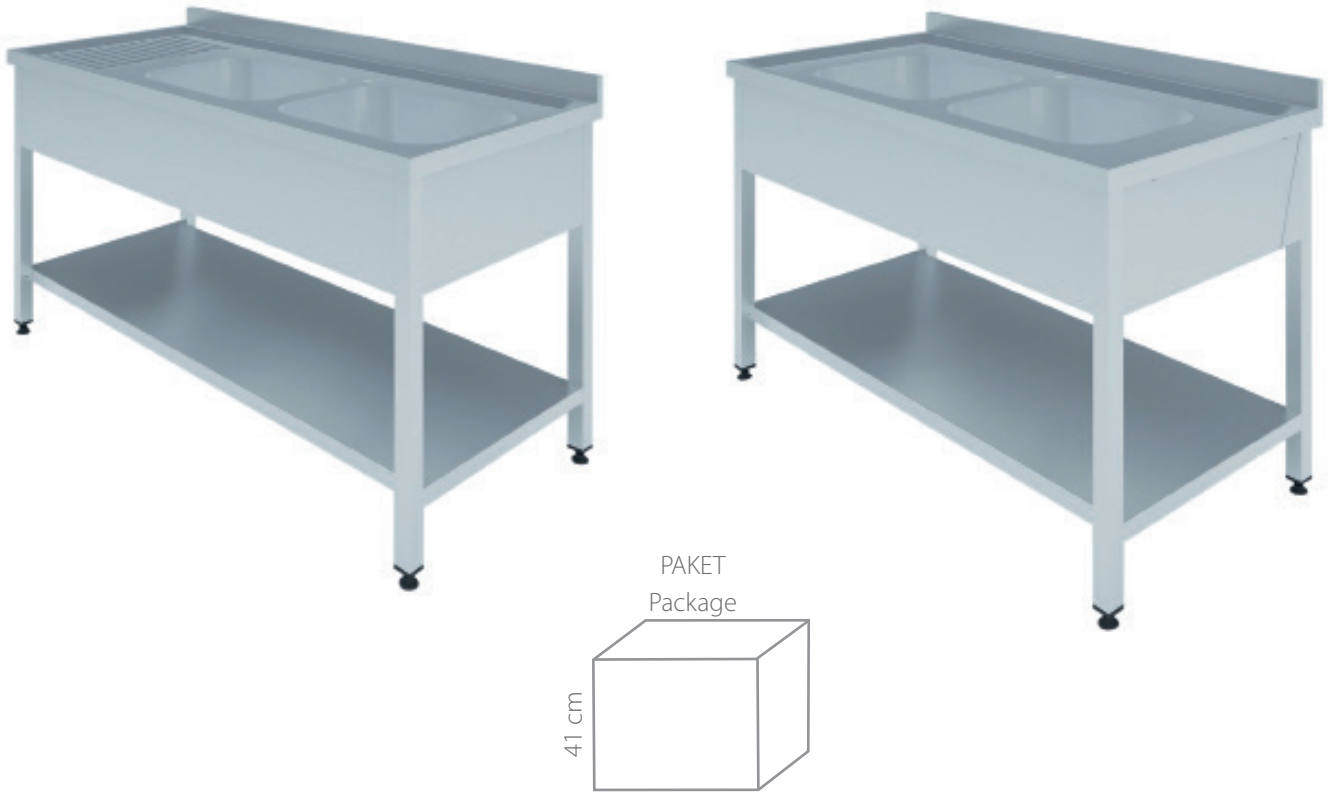

600 mm Demonte İki Evyeli Tezgah Sol

600 mm Dismountable Work Table With 1 Sink Left

KOD CODE	EBATLAR DIMENSIONS	KG KG	FİYAT PRICE
GAST-6CEDT12L	1200 x 600 x 850	32 Kg.	695 €
GAST-6CEDT14L	1400 x 600 x 850	35 Kg.	735 €
GAST-6CEDT16L	1600 x 600 x 850	39 Kg.	780 €
GAST-6CEDT18L	1800 x 600 x 850	41 Kg.	820 €
GAST-6CEDT19L	1900 x 600 x 850	45 Kg.	840 €

700 mm Demonte İki Evyeli Tezgah Sol

700 mm Dismountable Work Table With 1 Sink Left

KOD CODE	EBATLAR DIMENSIONS	KG KG	FİYAT PRICE
GAST-7CEDT12L	1200 x 700 x 850	35 Kg.	705 €
GAST-7CEDT14L	1400 x 700x 850	37 Kg.	735 €
GAST-7CEDT16L	1600 x 700 x 850	40 Kg.	760 €
GAST-7CEDT18L	1800 x 700 x 850	43 Kg.	830 €
GAST-7CEDT19L	1900 x 700 x 850	47 Kg.	880 €

600 mm Demonte İki Evyeli Tezgah Sağ

600 mm Dismountable Work Table With 1 Sink Right

KOD CODE	EBATLAR DIMENSIONS	KG KG	FİYAT PRICE
GAST-6CEDT14R	1400 x 600 x 850	35 Kg.	735 €
GAST-6CEDT16R	1600 x 600 x 850	39 Kg.	780 €
GAST-6CEDT18R	1800 x 600 x 850	41 Kg.	820 €
GAST-6CEDT19R	1900 x 600 x 850	45 Kg.	840 €

700 mm Demonte İki Evyeli Tezgah Sağ

700 mm Dismountable Work Table With 1 Sink Right

KOD CODE	EBATLAR DIMENSIONS	KG KG	FİYAT PRICE
GAST-7CEDT14R	1400 x 700 x 850	37 Kg.	735 €
GAST-7CEDT16R	1600 x 700 x 850	40 Kg.	760 €
GAST-7CEDT18R	1800 x 700 x 850	43 Kg.	830 €
GAST-7CEDT19R	1900 x 700 x 850	47 Kg.	880 €

BAR MODÜLLERİ

BAR MODULES / Modules de Barre







BAR MODÜLLERİ
BAR MODULES
Modules De Bar



BAR PREMİX TEZGAHI / BAR PREMIX BENCH / BANC BAR PREMIX**TR**

- Estetik tasarım
- Paslanmaz çelikten imal edilmiş gövde
- Kolay kullanım ve temizlik imkanı
- Demonte yapısı ile tüm yerlere yerleşme
- İstenilen ölçülere göre üretilebilme.

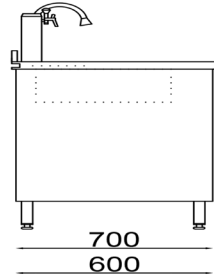
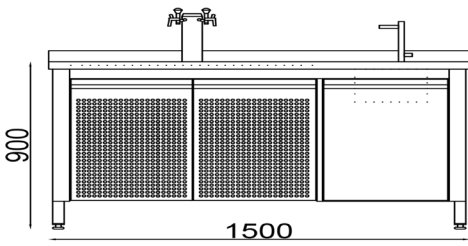
**GAST.BR100****BAR ŞİŞE STANDI / BAR BOTTLE SIT / BAR BOUTEILLE ASSIS****EN**

- Aesthetic design
- Body made of stainless steel
- Easy to use and clean
- Settlement in all places with its demountable structure
- Can be produced according to the desired dimensions.

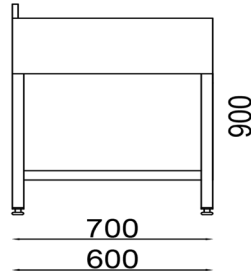
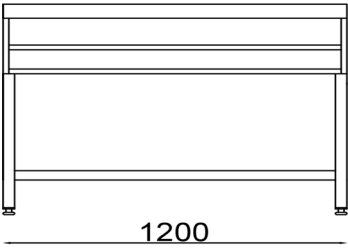
**GAST.BSS200****DOLAPLI BAR ŞİŞE STANDI / BAR BOTTLE STAND WITH CABINET / PORTE BOUTEILLE BAR AVEC ARMOIRE****FR**

- Conception esthétique
- Corps en acier inoxydable
- Facile à utiliser et à nettoyer
- Implantation en tous lieux grâce à sa structure démontable
- Peut être produit selon les dimensions désirées.

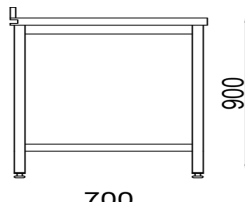
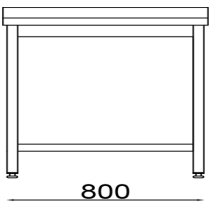
**GAST.DBS500**

BAR MODÜLERİ

BAR MODULES / Modules De Bar

BAR EVYESİ/ BAR SINK / ÉVIER DE BAR

TR

- Estetik tasarım
- Paslanmaz çelikten imal edilmiş gövde
- Kolay kullanım ve temizlik imkanı
- Demonte yapısı ile tüm yerlere yerleşme
- İstenilen ölçülere göre üretilebilme.



GAST.BEV100

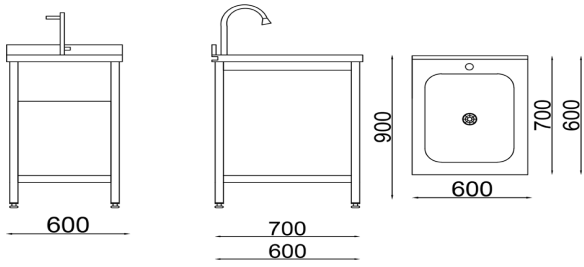

BAR HAZIRLIK STANDI / BAR PREPARATION / PRÉPARATION DE LA BARRE

EN

- Aesthetic design
- Body made of stainless steel
- Easy to use and clean
- Settlement in all places with its demountable structure
- Can be produced according to the desired dimensions.



GAST.BHS100

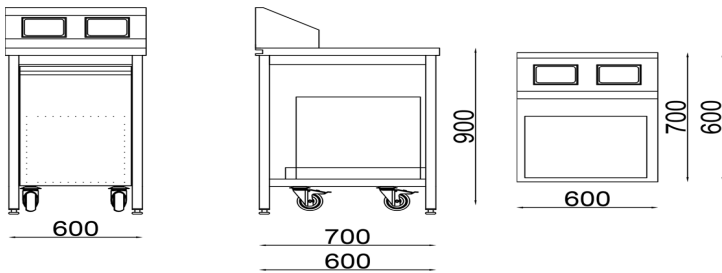

ÇÖP KOVALI BAR MODÜLÜ/ BAR MODULE WITH WASTE BUCKET/MODULE BAR AVEC SEAU A

FR

- Conception esthétique
- Corps en acier inoxydable
- Facile à utiliser et à nettoyer
- Implantation en tous lieux grâce à sa structure démontable
- Peut être produit selon les dimensions désirées.



GAST.BMC200

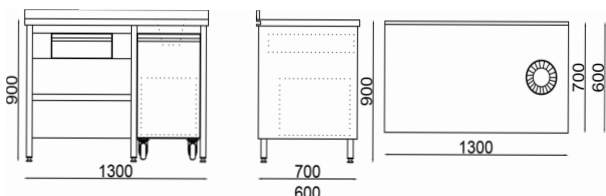

BAR MODÜLLERİ

BAR MODULES / Modules De Bar

BAR PREMİX TEZGAHI / BAR PREMIX BENCH / BANC BAR PREMIX

TR

- Estetik tasarım
- Paslanmaz çelikten imal edilmiş gövde
- Kolay kullanım ve temizlik imkanı
- Demonte yapısı ile tüm yerlere yerleşme
- İstenilen ölçülere göre üretilebilme.

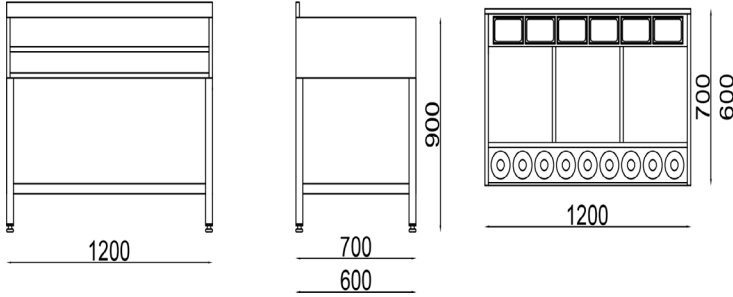

GAST.BS100

ÇEKMECELİ BAR STANDI / BAR STAND WITH DRAWERS / BAR STAND AVEC TIROIRS

EN

- Aesthetic design
- Body made of stainless steel
- Easy to use and clean
- Settlement in all places with its demountable structure
- Can be produced according to the desired dimensions.

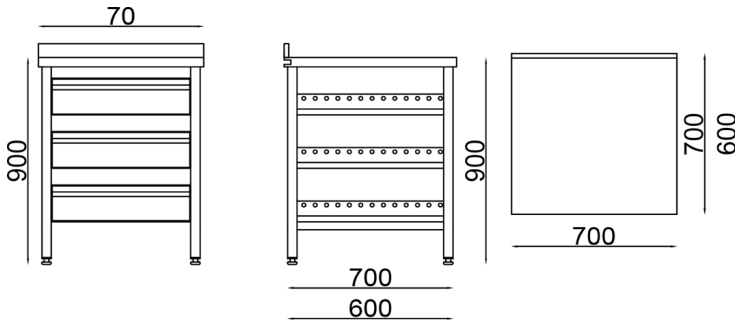

GAST.CBS100

BARDAK SÜZME MODÜLÜ / CUP FILTER MODULE / MODULE FILTRE TASSE

FR

- Conception esthétique
- Corps en acier inoxydable
- Facile à utiliser et à nettoyer
- Implantation en tous lieux grâce à sa structure démontable
- Peut être produit selon les dimensions désirées.

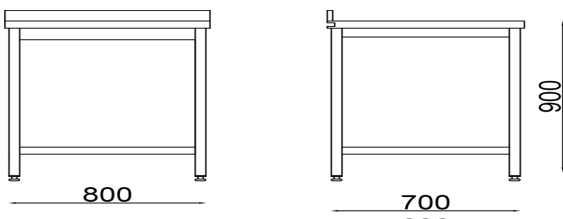

GAST.BSM100

GAST

Endüstriyel Mutfak ve Makine Sanayi

www.gast.com.tr - gastmutfak.com

info@gastmutfak.com



[gastmutfak](#)

[0 212 659 7176](tel:02126597176)



Ana Showroom :

Mahmutbey Mah. İstoç 23. Ada No: 9-11-13-15 Bağcılar/İSTANBUL

Tel : (90) 212 659 71 76

Showroom :

Mahmutbey Mah. İstoç 19. Ada 2438. Sokak No: 111, D:113, 34218 Bağcılar/İSTANBUL

Tel : (90) 212 71 77

Fabrika :

Kaptanpaşa Mah. Bahçecik Sokak No: 16 Şişli/İSTANBUL

(90) 212 419 63 03